

Looking after your **50 c. c. JAWA**

This lightweight motor-cycle, while enjoying many of the advantages of the moped, such as low first cost and cheap operation, bears all the marks of a true motor-cycle, for it had been designed as such from the outset. The small capacity of the engine is no indication of the effective usefulness of the machine which is to no little degree due to the the three-speed gearbox, which makes the Jawa a go-anywhere machine in the full sense of the word. Such advantages have gained the 50 c. c. Jawa popularity all over the world and the little machine is nowadays universally acclaimed as a fine means of transport to work or for pleasure.

This article comes to you directly from the engineering staff of the manufacturer, a concern which makes Manet scooters in addition to the 50 c. c. Jawa model. Owing to this range of products, the Povážské strojárne factory produces a common set

of specialized service tools for both these basic types, i. e. for the 50 c. c. Jawa model 555 and the Manet scooter, model S 100. Throughout this article, tools included in this set will be referred to by the letter N, whereas special tools previously made for the forerunner of the present model, the now obsolete 50 c. c. Jawa 550 will be marked P. These special tools are primarily intended for specialized workshops in order to facilitate their work and to improve the quality of repairs. The majority of these tasks can, however, be performed with the standard toolkit supplied with the machine, or with normal tools available in all countries. Various extractors and pullers can be substituted outside specialized workshops by universal extractors. In addition to these, there is a special crankcase separator used for splitting the two crankcase halves apart. A detailed drawing of this tool will be printed to enable all interested (in particular

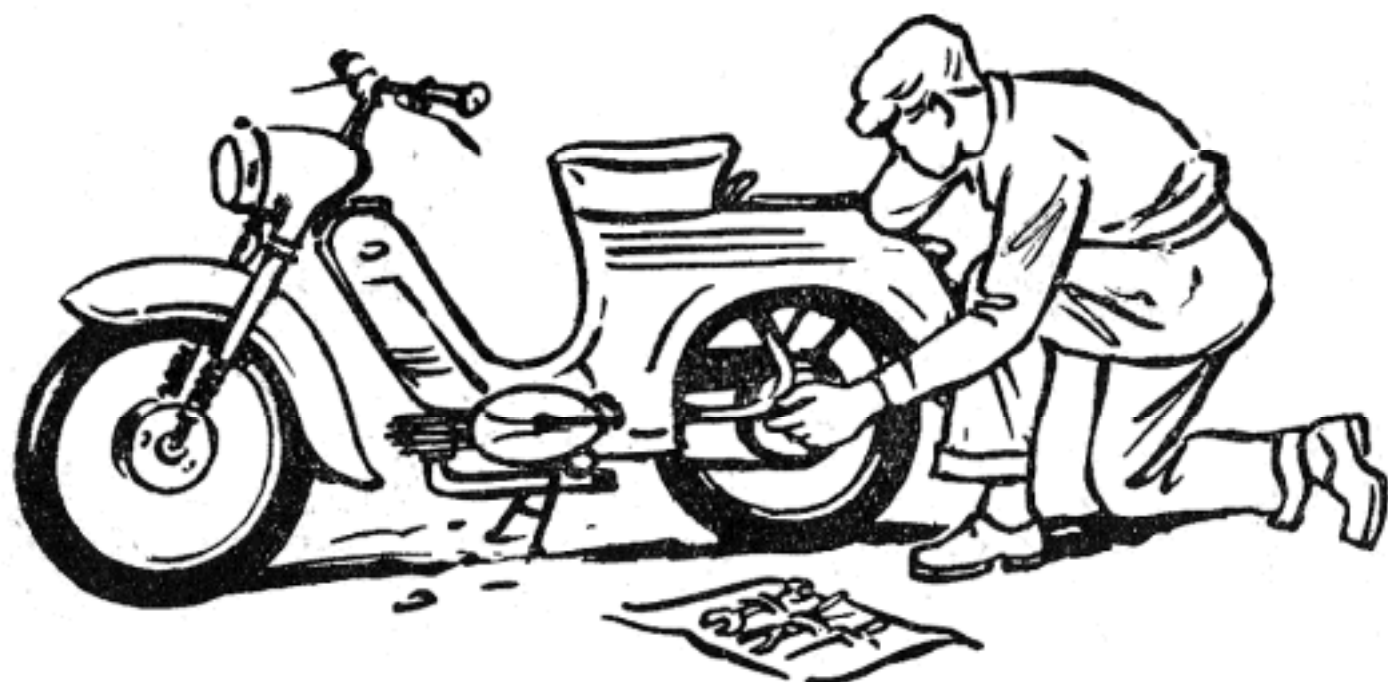



Above: The 50 c. c. ultra-lightweight Jawa motor-cycle, model 550. Specification of model 555: engine - single-cylinder, two-stroke, air-cooled. Bore 38 mm, stroke 44 mm, swept volume 49,8 c. c., compression ratio 7 : 1, power output 2,2 b. h. p. at 5500 r. p. m. Jikov 2914 carburetter, three speed gearbox, primary transmission and final drive by chain. Magneto-generator ignition, 6 V, 18 W generator output. Overall length 1780 mm (71 ins.), width across handlebar 560 mm (22 ins.), overall height 938 mm (37 ins.), weight 54 kg (119 lbs.). Top speed 60 km p. h. (38 m. p. h.), fuel consumption 1,8 litre per 100 km (157 m. p. g.). Maximum gradient climbed 22 per cent.



members of clubs owning amateur workshops) to make their own. This tool is, however, intended only for general overhauls and is thus seldom required.

The works technicians have answered our request and have written their contribution in such an order, as to mention first of all those tasks which can be undertaken without dismantling the vehicle, then jobs requiring dismantling. Assembly of parts is in reverse order to dismantling and numerous illustrations are included for clarity's sake.

Carburettor cleaning and maintenance

The most common cause of carburation troubles is dirt entering the carburettor with fuel or inducted air. The interval for regular carburettor cleaning should be set with a view to prevalent conditions of operation. Carburettor trouble from other causes has not been experienced. Should the throttle slide vibrate within its chamber producing a ringing noise, the cause is excessive wear and a replacement slide must be fitted. In cases of throttle slide seizure,

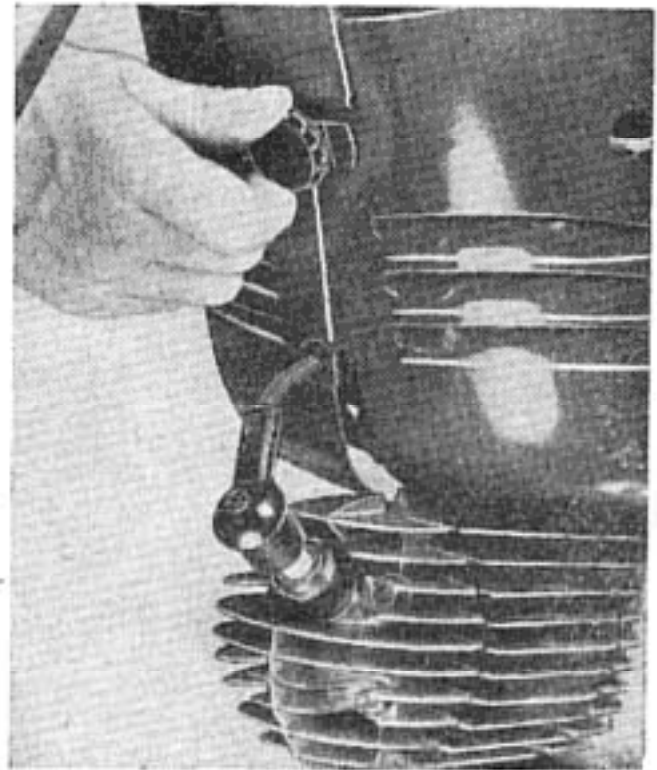
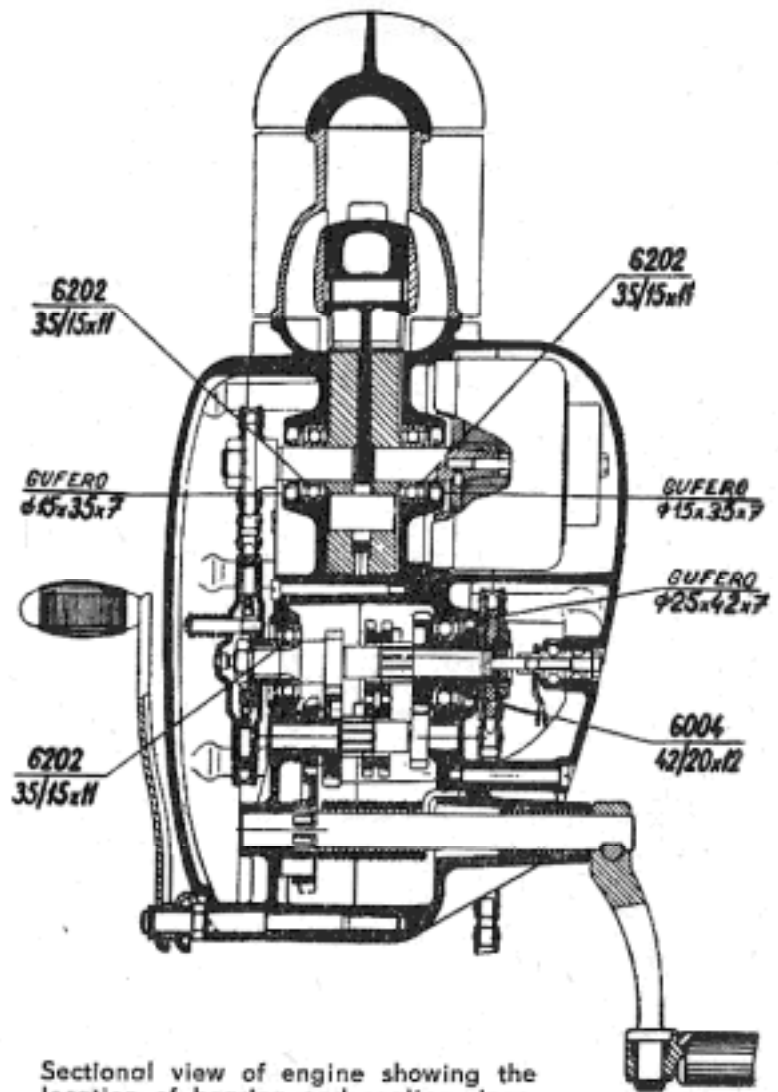
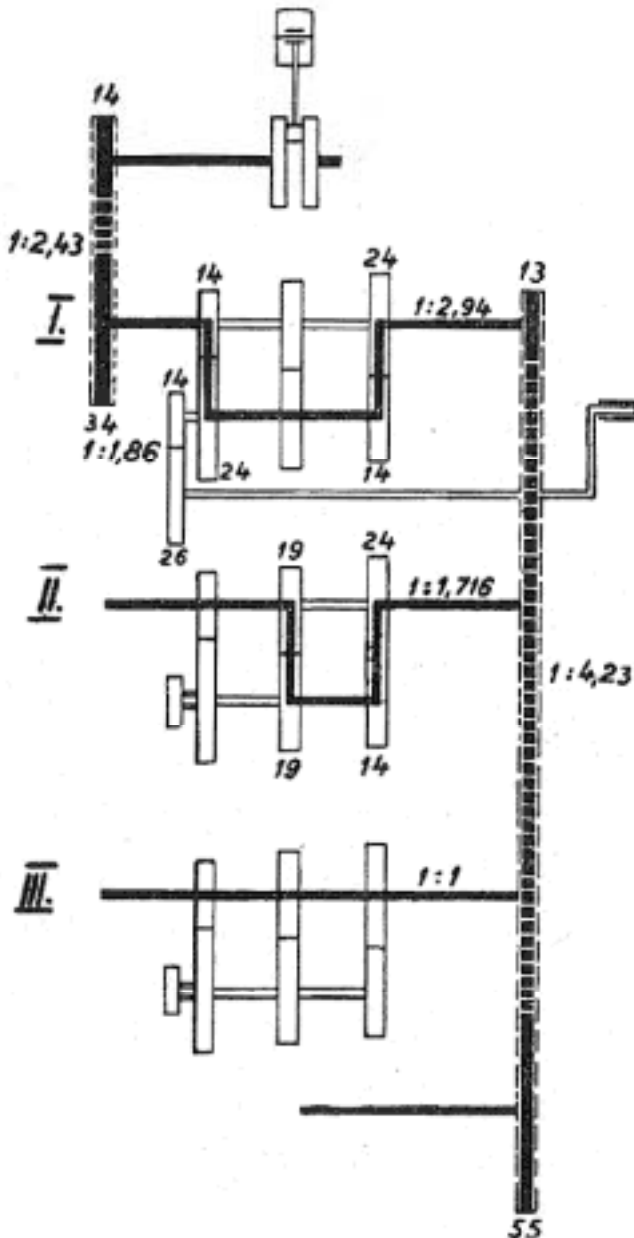

Fig. 1

Transmission in diagrammatic form.



Sectional view of engine showing the location of bearing and sealing rings.

the slide chamber must be reamed to the required diameter. Float leakage, usually caused by misuse of the tickler, can be cured by soldering (after the float is left to dry) or by fitting a replacement float. In case of a leaking float needle valve, regrind the needle in its seat in the float chamber lid using grinding paste, or replace both parts. For cleaning, the instrument must be removed from the machine. In order to gain access, both the halves of the front shroud inspection cover must be opened (Fig. 1).

The JIKOV 2914 Hz carburettor (Fig. 2). This type used to be fitted to 50 c. c. Jawa 555 models. Turn

the petrol tap to "off" position, disconnect the tubing and turn the tap to "on" position to check the fuel line from the tank for free flow. Should it be restricted, remove the tap and clean its gauze strainer. In order to clean the carburettor proper, remove the mixing chamber cover retaining nut (20), unscrew the slide guide screw a few turns (23) and remove the throttle slide (16) together with its needle (17), which according to factory recommendation should be attached by the clip (18) in the second groove of the needle from top. Then slacken screw (26) and remove the carburettor from the engine. This same screw also locates the air

Fig. 2

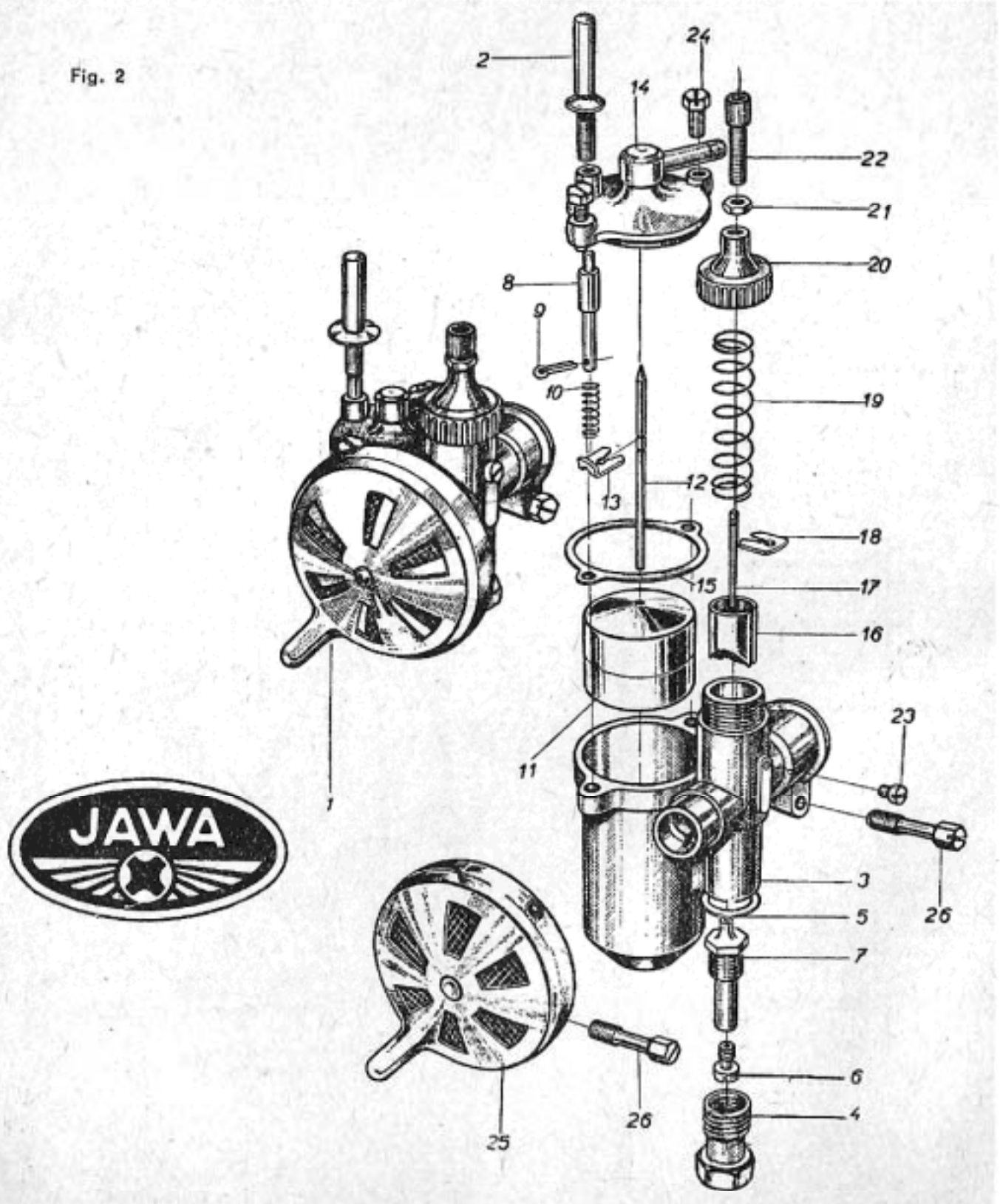

cleaner which must always be washed in petrol. The correct sequence is, of course, first to wash the carburetter components in clean petrol and then to use this petrol for the filter. Filtering efficiency may be improved after cleaning by smearing a thin film of oil over the cleaner. The carburetter jet (6) of size 65 is made accessible by the removal of screw (4). Remove two screws (24) and the float chamber lid (14) taking care not to damage sealing gasket (15), after which the float (11) may be withdrawn together with the float needle which is secured by clip (13). If there is any need to remove the throttle slide (16) from its cable, press it against the action of spring (19) and the cable can then be removed from its groove. Assemble in reverse sequence.

The JIKOV 2912 carburetter (Fig. 3). This instrument is fitted to the 50 c. c. Jawa, model 550. First disconnect petrol hose, check for free flow of fuel and dismantle as follows: unscrew the mixing cham-

ber lid retaining ring nut (25), unscrew the slide guide screw a few turns (8) and remove the throttle slide (18). Remove the carburetter from the engine. After slipping off flat spring (30), dismantle the air cleaner and clean thoroughly. The hose union (7) leading to the float chamber should be removed by slackening nut (6). The strainer found below it should be cleaned. Strip the float chamber by removing two screws (19) and the chamber lid (22) with the sealing gasket (17) after which the float complete with needle (20) may be withdrawn. Access to the carburetter jet (12) is gained by removal of screw (19) with its sealing washer (15). Clean all parts in petrol, clean the air cleaner and reassemble in reverse sequence. To remove control cable from throttle slide, compress springs and withdraw sideways. Control cable backlash is adjusted by turning adjuster screw (4) and retaining nut (5). When fitting to the engine, remember to replace sealing gasket (2).

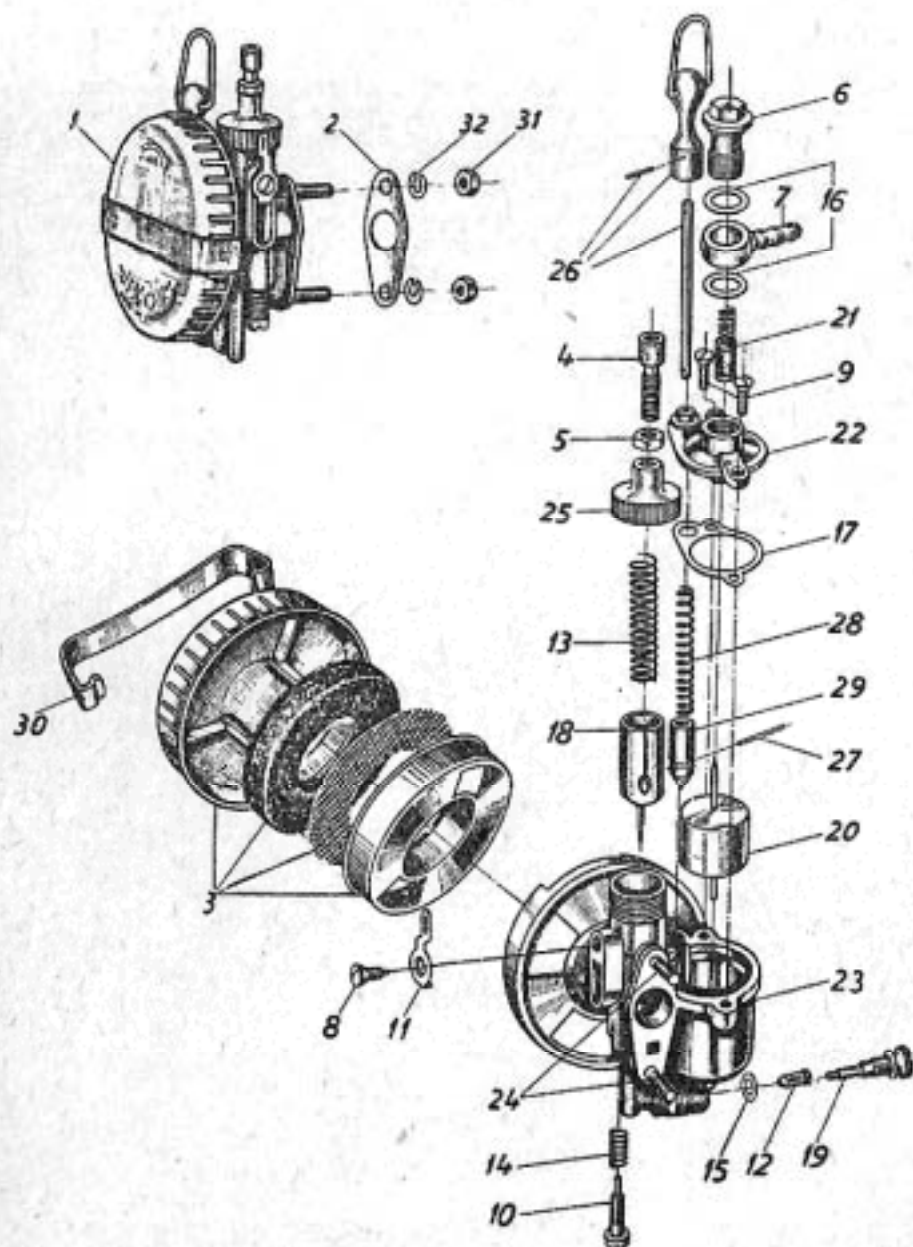

Fig. 3



The engine

The following tasks can be carried out without removing the engine from the frame: removal of cylinder head and barrel for decarbonizing or rebore, cleaning or replacing piston, fitting new little end bushes, setting ignition advance, stripping flywheel magneto, replacement of either engine or gearbox sprocket, replacement of either chain, replacement or adjustment of clutch, renewal of "Gufero" sealing rings.

To remove cylinder head and barrel. Open both halves of the frontal shroud (Fig. 1) and remove carburetter. Remove two screws attaching exhaust pipe to exhaust flange on engine, remove bolt attaching exhaust pipe to frame and remove exhaust pipe. Using tubular spanner included in tool-kit or special tool N 37 (Fig. 4), slacken four head-retaining nuts and remove them together with washers. Should difficulty be experienced when trying to lift off the head, free it by jarring gently with a wooden or rubber mallet or by careful prising with two screwdrivers. Free the cylinder by prising only (Fig. 5) after moving the piston to b. d. c. by depressing the kick starter lever. Remove cylinder barrel and cover crankcase opening by clean rag. Thus the engine is prepared for decarbonizing, piston replacement, or renewal of little end bushes. The piston rings are removed using special remover pliers or special tool N 31 (P 7) or with the aid of three strips of thin sheet metal. The piston should be removed only for replacement or for replacement of the gudgeon pin or little end bush. To remove piston, first extract both circlips retaining the gudgeon pin and then remove the gudgeon pin itself using the special gudgeon pin extractor N 7 (P 9), Fig. 6. Do not drive out the bush or gudgeon pin by blows, for this may result in a bent connecting rod.

Fitting the little end bush. Hammer blows are ruled out in this operation as well as bush removal, which must always be done with the aid of an ex-

Fig. 4

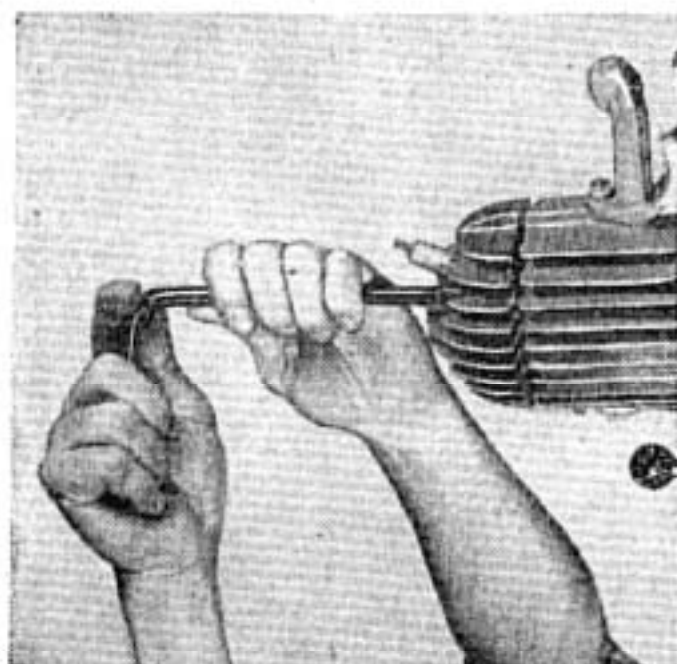

tractor. Removal of the bush will be described in our forthcoming articles, for it is similar in principle to the same operation on all Jawa-ČZ motorcycles. Before fitting the bush, heat the little end with naked flame to 80 deg. C (175 deg. F), using, for instance a blowlamp. This will expand the eye and permit insertion of the bush. Heat the connecting rod only by direct application of flame to the vicinity of the little end and take great care not to heat the big end, for the big end bush is hardened. After fitting and letting to cool down, the bush should be reamed out to fit the gudgeon pin.

To fit piston. Heat the piston in hot air (not by direct application of flame as in the case of the connecting rod) to 80 deg. C (175 deg. F), slip it over the connecting rod and press the gudgeon pin through the piston and little end bushes. Should the pin not be located between the two circlip grooves, it may be moved using the gudgeon pin extractor. Then refit the piston rings, each to its respective groove in which it had been before stripping.

Selective grading of pistons and cylinders. Pistons and cylinders are graded according to their precise diameters into three classes (A, B, C) and the letter is always stamped into both the piston and the cylinder. After reboring and honing, the cylinder must be marked by the corresponding letter. The correct dimensions for rebored cylinders are given in the table printed below. Piston diameter mea-

Fig. 5

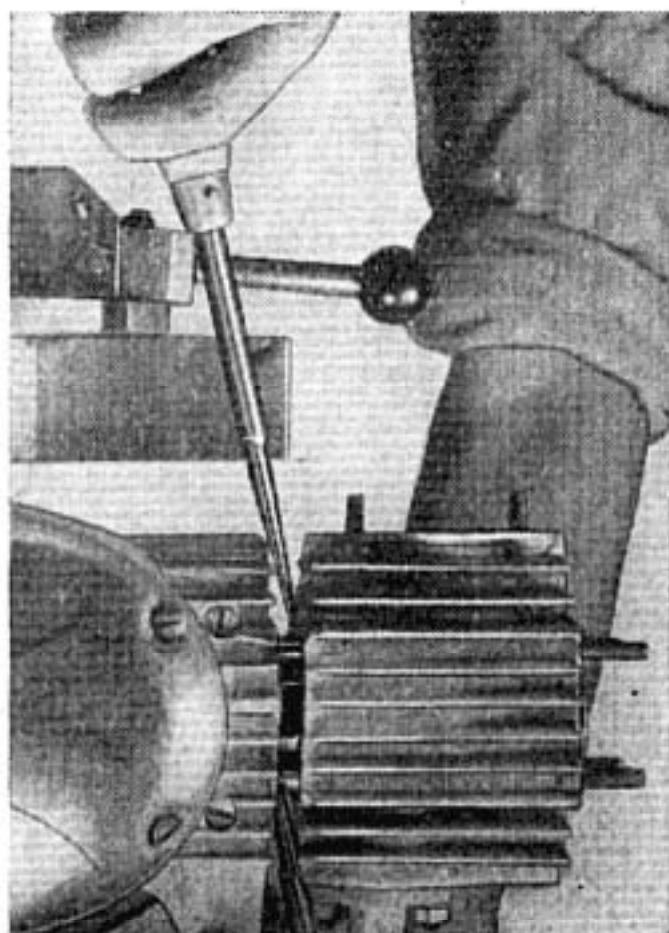

measurements are taken 32 mm above the bottom skirt edge.

Cylinder grades and dimensions

	A	B	C
standard size	$38,00 + 0,006$	$38,006 + 0,005$	$38,011 + 0,005$
1st rebore	$38,25 + 0,006$	$38,256 + 0,005$	$38,261 + 0,005$
2nd rebore	$38,50 + 0,006$	$38,506 + 0,005$	$38,511 + 0,005$
3rd rebore	$38,75 + 0,006$	$38,756 + 0,005$	$38,761 + 0,005$
4th rebore	$39,00 + 0,006$	$39,006 + 0,005$	$39,011 + 0,005$

Piston grades and dimensions

	A	B	C
standard size	$37,94 + 0,00$ $- 0,01$	$37,95 + 0,00$ $- 0,01$	$37,96 + 0,00$ $- 0,01$
1st rebore	$38,19 + 0,00$ $- 0,01$	$38,20 + 0,00$ $- 0,01$	$38,21 + 0,00$ $- 0,01$
2nd rebore	$38,44 + 0,00$ $- 0,01$	$38,45 + 0,00$ $- 0,01$	$38,46 + 0,00$ $- 0,01$
3rd rebore	$38,69 + 0,00$ $- 0,01$	$38,70 + 0,00$ $- 0,01$	$38,71 + 0,00$ $- 0,01$
4th rebore	$38,94 + 0,00$ $- 0,01$	$38,95 + 0,00$ $- 0,01$	$38,96 + 0,00$ $- 0,01$

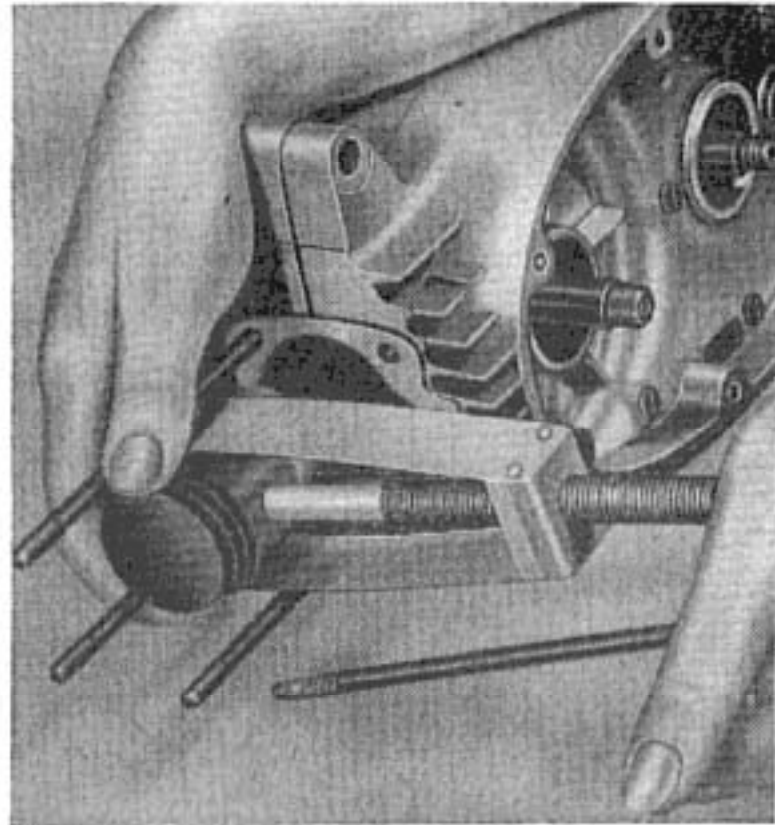

Fig. 6

To fit cylinder barrel and head. Thoroughly clean the joint surface on the crankcase, place gasket on underside of the cylinder (preferably a new one) and smear the cylinder bore with oil. Using the kick starter lever, move the piston to t. d. c. and slip the cylinder over the piston. Replace the head gasket (preferably fit a new one) and take care to fit a washer under each head retaining nut. The nuts are easily located on their studs with the aid of a rod or screwdriver (Fig. 7).

To remove gear and kick starter levers. (Fig. 8.) Using small screwdriver or a needle, remove the

Fig. 7

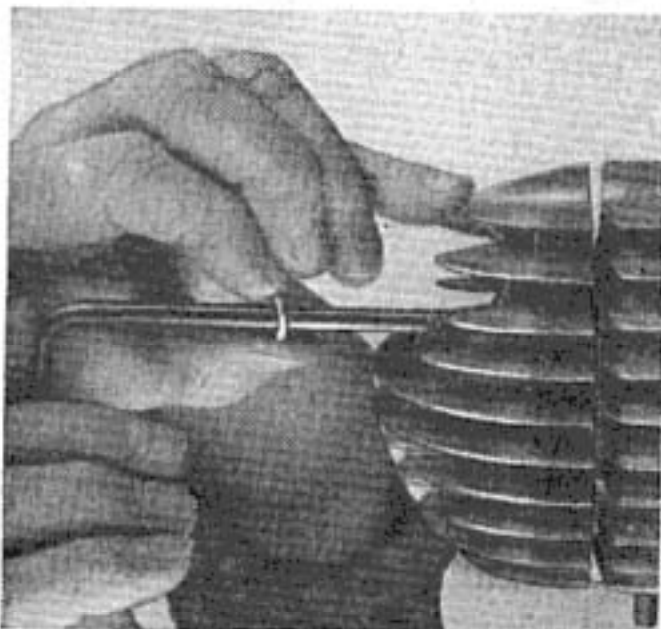
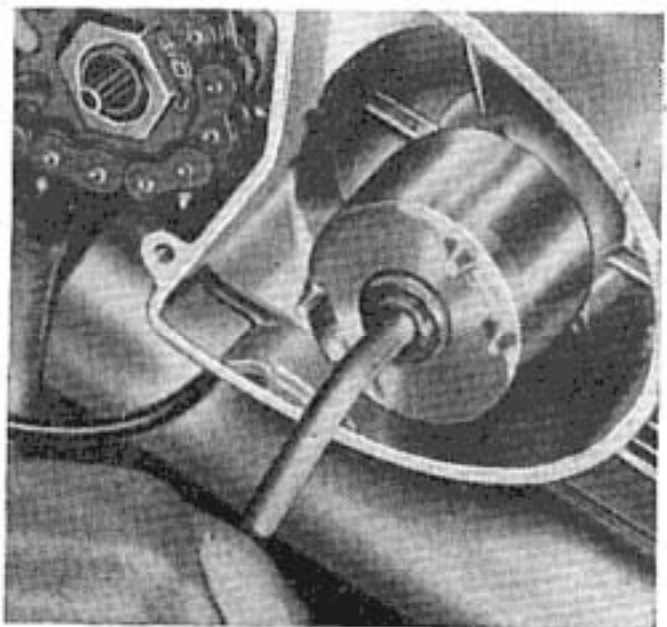

Fig. 10



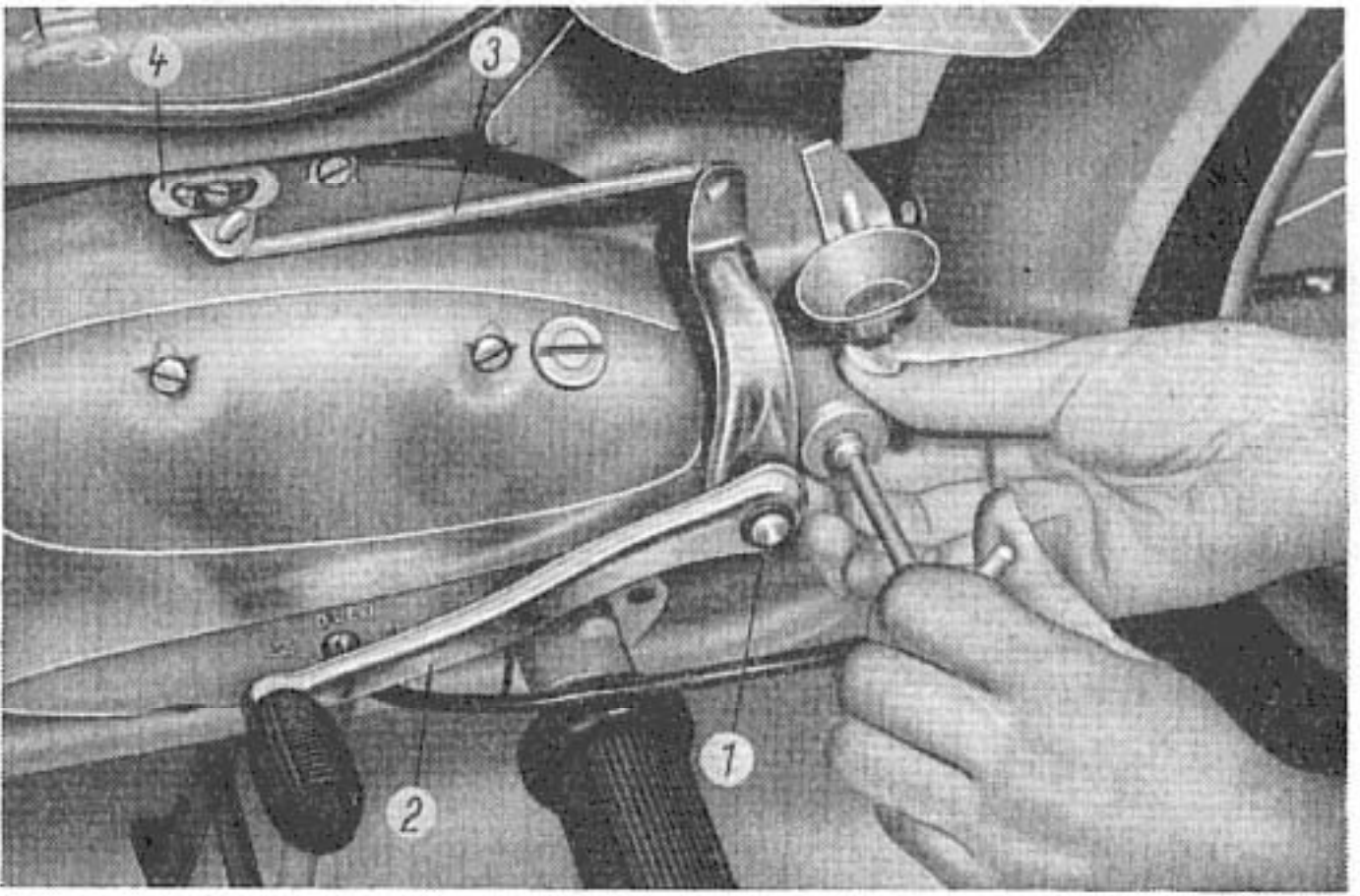
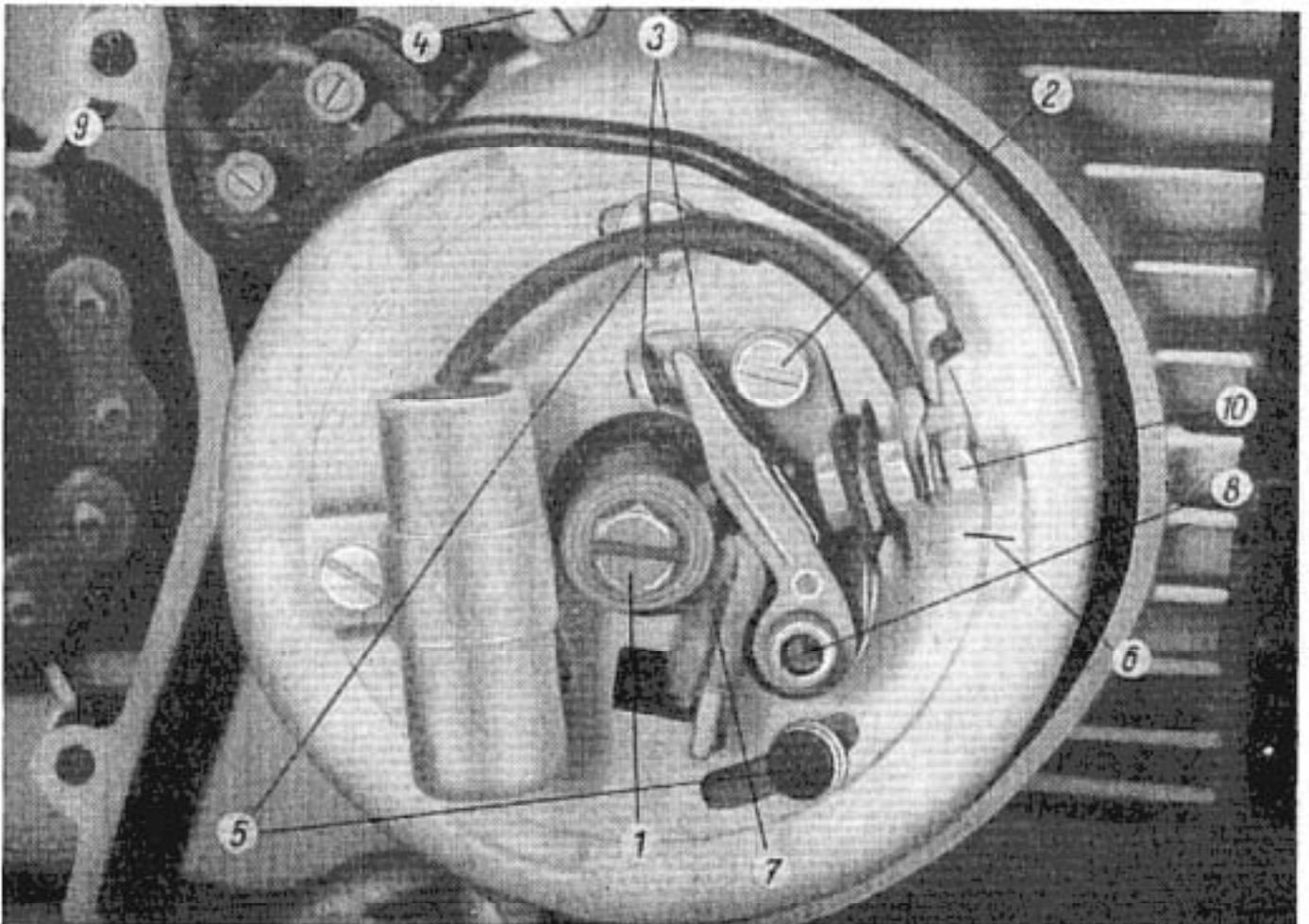

Fig. 8

Fig. 9



retaining circlip (1) and the adjacent plain washer from the splined eye of the gear lever (2). Then remove the lever (2) and disconnect tie rod (3). To remove the kick starter lever on the opposite side remove the M6 nut of the cotter pin and force this pin out.

To set ignition advance. (Fig. 9.) The correct ignition setting as recommended by the makers is 2,8 to 3,1 mm before t. d. c. and the following is the procedure for obtaining it. Remove the spark plug and screw into its hole the special N 29 piston positioning gauge or a similar, universal tool. If no such special gauge is available, remove the cylinder head and use a normal sliding depth gauge. Then strip the starter lever and remove the RH engine side cover. Turn bolt (1) clockwise until the piston is set at t. d. c. Then release screw (2) and set the gap between points (3) at 0,35 to 0,4 mm using the feeler gauge included in the standard toolkit. Check the surfaces of the points, which must be clean, and tighten screw (2). By rotating bolt (1) anti-clockwise set the piston at 2,8 to 3,1 mm before top dead centre. With the piston thus positioned, there should be just 0,05 mm clearance between the points, i. e. a normal cigarette paper should be a sliding fit. Should the gap be more or less than 0,05 mm, adjust it by slackening two anchor bolts (4) and turning the whole yoke (stator) clockwise for retarding ignition and anti-clockwise for advancing it. After setting the gap tighten bolts (4). Screws (5) which attach the contact breaker base-plate and the condenser to the stator body should never be slackened in the course of ignition timing. The base plate is adjusted for position by the manufacturers who use an oscillograph for this purpose in order to ensure the most suitable tension for ignition and lighting. There are three tabs on the stator to ensure correct centering of the contact breaker base-plate. On one of these tabs, the correct position of the contact breaker base-plate in relation to the stator is scribed (6). Should the contact breaker base-plate have to be removed for some reason and no such mark is found beforehand, it should be scribed with a needle or sharp pencil before doing so. When checking the ignition setting, make sure that the felt strip (7) is amply lubricated with oil and that it makes contact with the contact breaker cam lobe. The rocker pivot (8) should be greased slightly, but under no circumstances may grease find its way to the contact breaker points.

To dismantle magneto (Fig. 9). Disconnect cables from terminal panel (9) and the upper lead to the contact breaker after loosening nut (10), remove bolts (4) and detach the stator. Remove bolt (1) attaching the rotor and cam to the crankshaft journal and remove the cam. Thread special extractor N 44 or a long M8 bolt into the boss for bolt (1), (Fig. 10). Holding the rotor with one hand and turning the screw with the other, proceed until the rotor comes free of the journal. Then remove the dowel pin securing the rotor against rotation on the journal. After removal, the rotor should be re-inserted into the stator with a minimum of delay or must be protected from loss of magnetic properties by some other means, such as the special clamp P 29 or by wrapping light gauge mild steel sheet around it.

To remove the gearbox sprocket. After removing the kick starter lever and the engine side cover, flatten the tabs securing the sprocket nut. This may be done with tool N 26 (P 10) and for the nut use spanner N 40. Then disconnect the rear chain and using extractor N 8 remove the sprocket. Place a flat spanner under the extractor bolt in order to prevent damaging the sprocket seal insert (Fig. 11).

To dismantle primary drive and clutch. Remove the gear lever and unscrew the drain plug at the

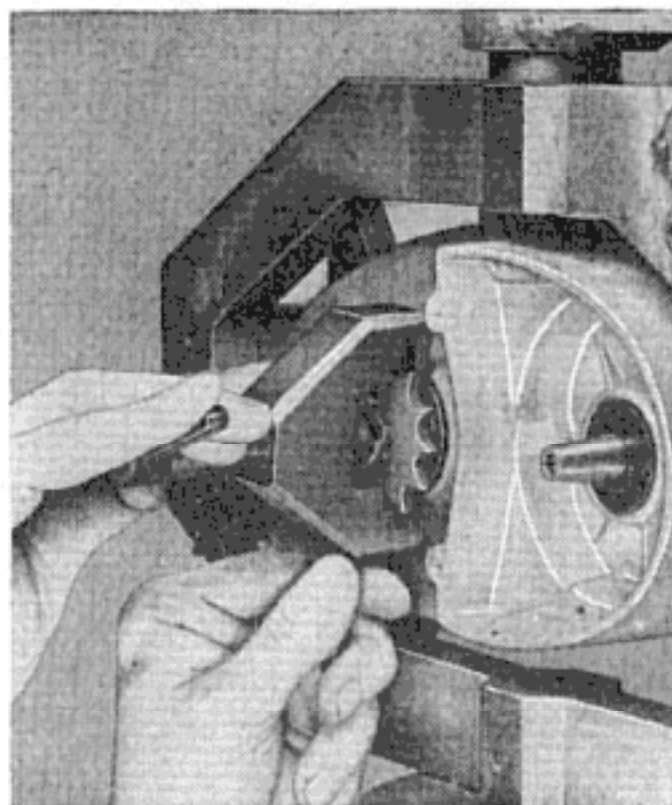

Fig. 11

Fig. 12



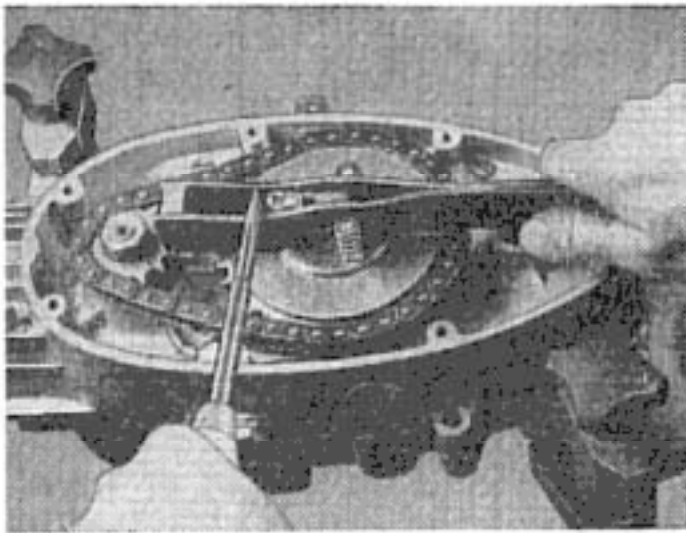

Fig. 13

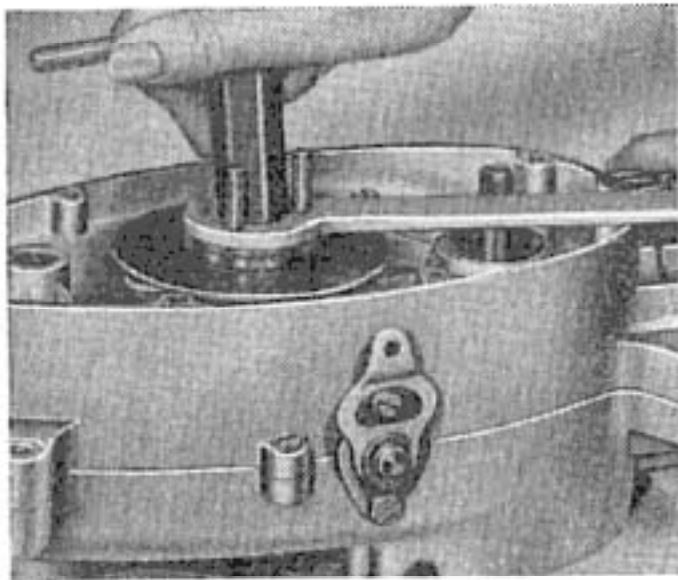
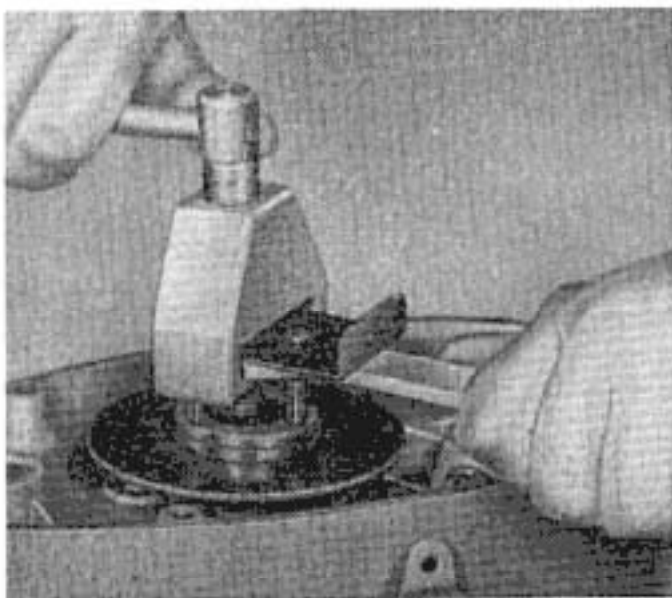

Fig. 14

Fig. 15



bottom of the crankcase in order to drain the oil. Using a well-fitting screwdriver, remove all the retaining screws of the LH engine side cover and using a spanner (14) remove the gear lever pivot bolt from the rear end of the LH engine side cover. (During reassembly take care to replace the washer under the head of this bolt.) The side cover is sometimes stuck to the crankcase casting and must be freed by careful prising with two screwdrivers. (When refitting remember to fit the old gasket only if it is undamaged.) Using compressing lever N 46 and its adapter N 58 compress the clutch springs one by one and remove their retaining washers (Fig. 13). Remove the primary chain and the clutch chain-wheel. Using the tab flattener N 26 (P 10) or a large screwdriver flatten the tab washer securing the crankshaft sprocket retaining nut, and fixing the sprocket by the insertion of sprag N 51 (P 16), unscrew the retaining nut using spanner N 40. Note that there is a **LEFTHAND THREAD!** Remove the sprocket with the spring washer. Extractor N 9 (P 11) should be used for pulling the sprocket off the crankshaft journal pin (Fig. 12). Flatten the tab washer securing the retaining nut of the fixed clutch plate, using tool N. 26. Slip securing adapter N 42 over the fixed plate studs and using a tubular spanner remove the clutch retaining nut (Fig. 14.) Secure the lever N 42 against slipping out by the securing plate N 52 inserted into the stud grooves and using extractor N 9 (P 27) detach the fixed plate of the clutch (Fig. 15).

Renewing the Gufera sealing rings. To remove the sealing ring on the LH end of the crankshaft, the sprocket must be detached from the crankshaft journal as described in the paragraph headed "To dismantle primary drive and clutch". Remove the ring with extractor N 12 (P 11). The sealing ring on the other end of the crankshaft is removed in the same manner after stripping the magneto, of course. The sealing ring under the gearbox sprocket can be extracted after removal of the sprocket which has already been dealt with. Fig. 16 shows how to extract the sealing ring. New sealing rings are fitted with the aid of driving bush N 56 or a tube having

Fig. 16

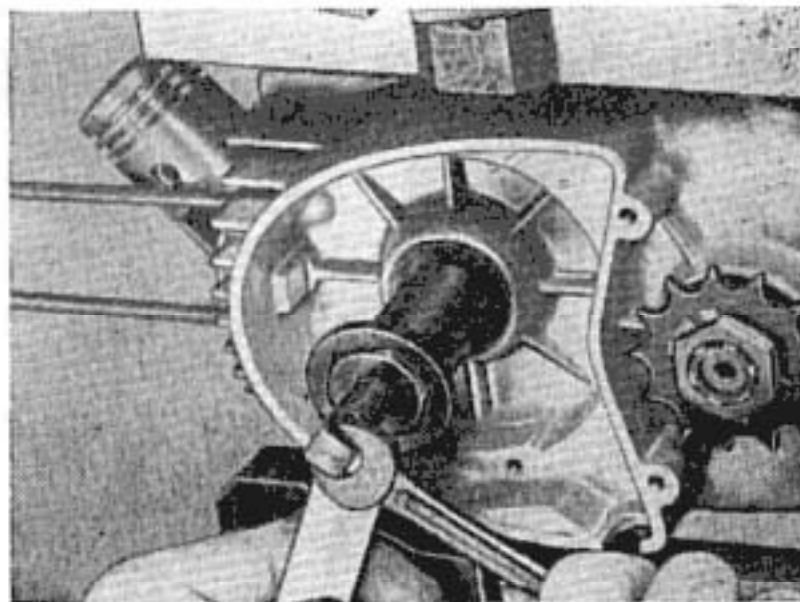
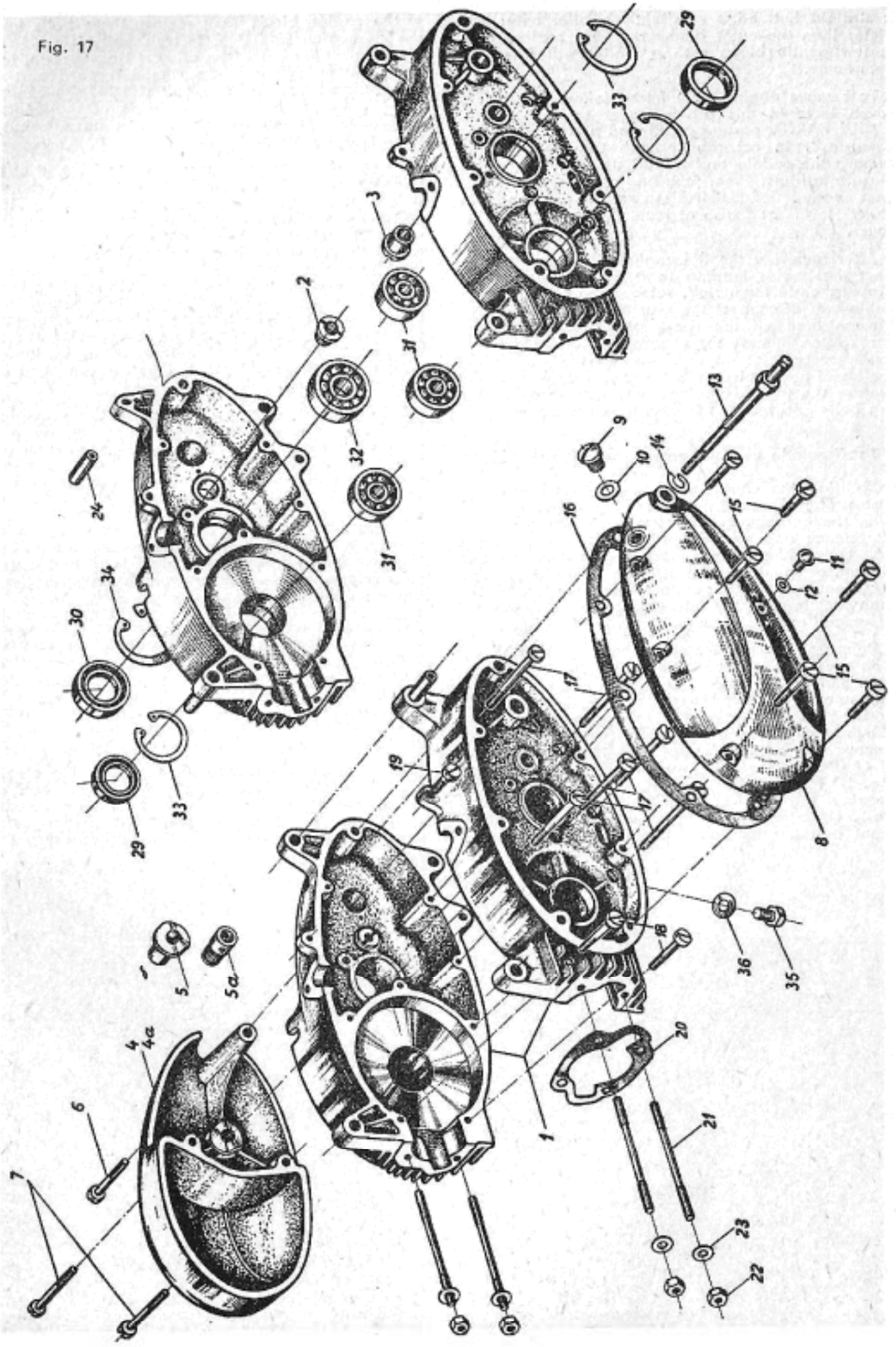

Fig. 17



a straight butt edge of slightly smaller outer diameter than the outer diameter of the sealing ring. A few gentle blows with a mallet will drive the seal home.

To remove engine from frame follow instructions given later in this article under the heading of CYCLE PARTS, paragraph "To strip frame and accessories". In accordance with these instructions remove the saddle and frontal as well as rear enclosure fairings. Then, following advice given in the part headed THE ENGINE remove the gear and kick starter levers and also at least the RH engine side cover.

After removing the RH engine side cover disconnect the cables leading to it as described under "To dismantle magneto", release the clutch control cable and disconnect the rear chain. Take the high tension lead off the spark plug and detach the carburetter. Remove the exhaust silencer, disconnect the gear selector tie rod, unscrew the nut on the footbrake pedal pivot, disconnect the brake rod and remove the pedal. Finally remove the three engine lug bolts and free the engine from the frame.

To dismantle gearbox and crankshaft assembly

Splitting the engine-gearbox castings apart and dismantling the crankshaft assembly as well as stripping the gearbox are tasks which demand a little experience and should not be undertaken for the first time without the guidance of an experienced person, or should be entrusted to a specialist workshop equipped with special tools supplied by the manufacturers. In the following instructions the use of special tools is assumed.

Before splitting the engine-gearbox unit, the RH side cover has already been removed and the magneto should be removed too - see "To dismantle magneto". From the LH side remove the gear lever and the LH cover, then dismantle primary drive and clutch as described before under that heading. Then remove the cylinder barrel and head. Using tool N 47 (P 2) remove the two centering bushes (24 in Fig. 17) from the front and rear lugs in the engine housing, through which the engine mounting bolts pass. Unscrew the gearchange mechanism attachment bolt on the upper part of the rear portion

of the engine block. Then remove these bolts from the LH engine side (Fig. 17): six bolts (17) M5X50 from the region below the primary transmission, two bolts (18) M5X40 from the finned forward part of the engine block and one bolt (19) M5X18 connecting the bosses on the upper side of the engine block. Bolt (13) in its rear portion has obviously been removed beforehand.

Fit the special engine separator tool N3 (P 6) to the LH side of the engine block so that the central bolt bears on the crankshaft journal pin (Fig. 18). Check the tool for correct fitting and then turn the central bolt to press against the crankshaft journal until both halves of the engine begin to come apart. Care should be taken to ensure that both halves separate evenly, and should any tendency to bind be observed, even clearance over the whole of the broken joint must be obtained by careful tapping at the narrowest point. If care is taken to ensure even separation, the separator bolt may be turned until the LH engine block half is free and can be removed by hand.

To dismantle gearbox. Withdraw the engaging fork guide pin and withdraw the engaging fork (Fig. 19). Remove the end clearance shim from the layshaft. It is most important to remember to replace it at this end during reassembly! Withdraw the layshaft together with the gearwheels (Fig. 20). Release the starter shaft spring from its anchor hole in the RH half of the engine block casting and remove the starter shaft together with the quadrant (Fig. 21). Unscrew from above the RH attachment bolt of the gear selector mechanism and withdraw the mechanism from the gearbox.

Remove the mainshaft and gearwheel. If the gearwheel with boss or "constant pinion" or only its bearing is to be renewed, first remove the gearbox sprocket (see "To remove gearbox sprocket"). Then remove the "Gufero" seal and taking care not to damage the thread on the end of the boss, force the gearwheel with the boss towards the middle of the gearbox.

To dismantle the crankshaft assembly. The crankshaft assembly, which remains in the RH half of the engine block casting should be withdrawn only if the big end bearing or the RH crankshaft main bearing must be repaired or renewed. Press the

Fig. 18

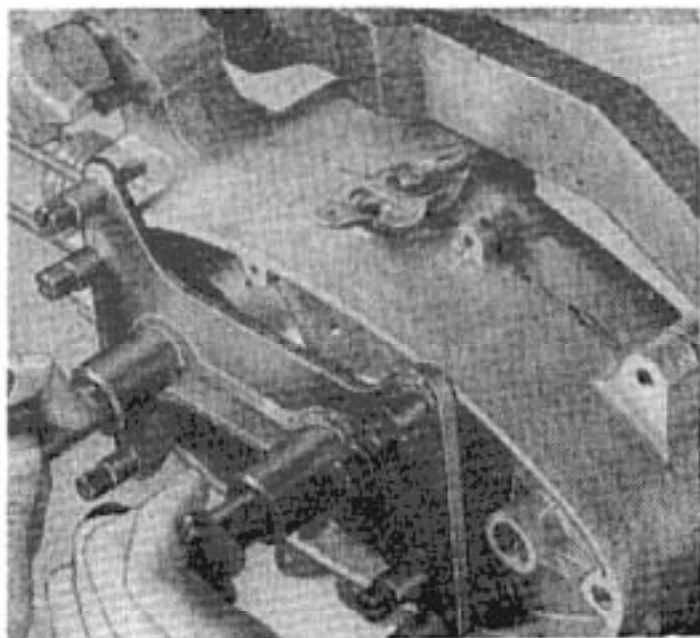
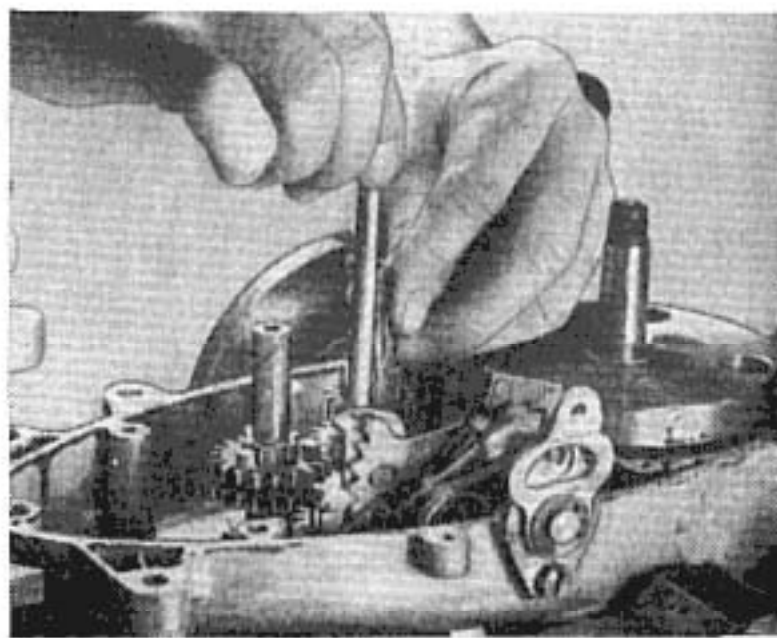

Fig. 19



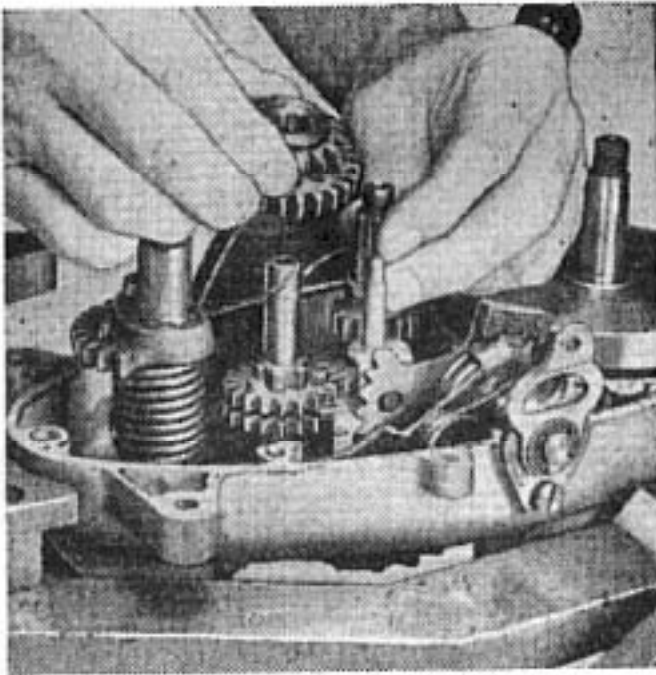

Fig. 20

crankshaft out of this half of the crankcase using special engine splitting tool N 3 (P 6), fitted in the manner employed for separating the crankcase halves. The various components of the crankshaft proper may be pressed apart and repaired only by a specialist workshop. When replacing the crankshaft assembly, hand pressure should suffice to push it into the RH journal bearing. When fitting the LH crankcase half over the crankshaft, the LH journal thread must be protected by cap N 27 (P 13).

To align the crankshaft. Tolerated eccentricity of crankshaft main journals amounts to $\pm 0,01$ mm and the maximum eccentricity between the flywheel periphery and the journals amounts to $\pm 0,02$ mm. The axial tolerance of the flywheels is $d 11$. Both crankshaft journals must be aligned with the plane

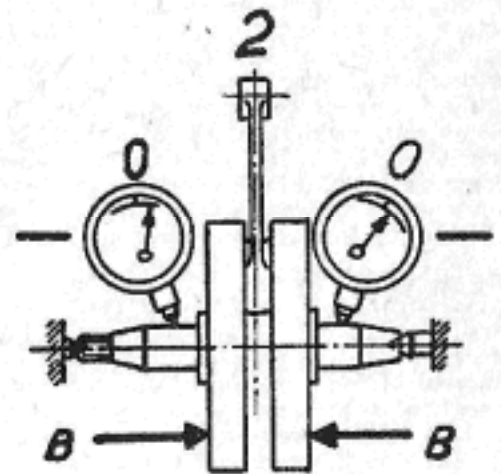
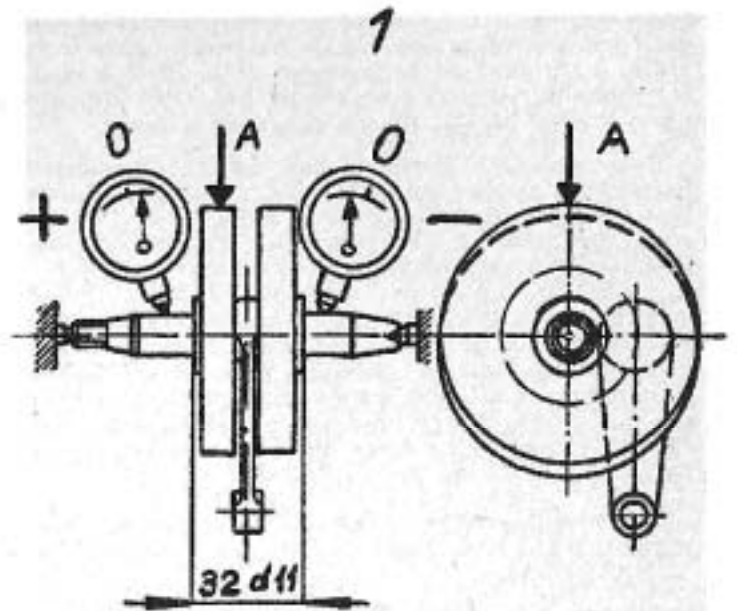

Fig. 21

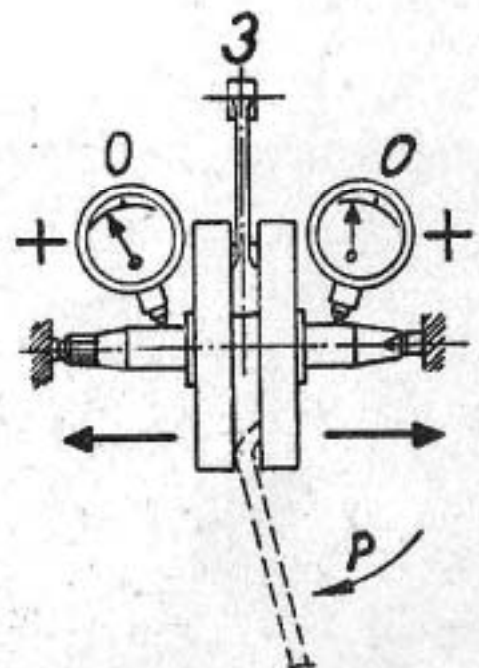
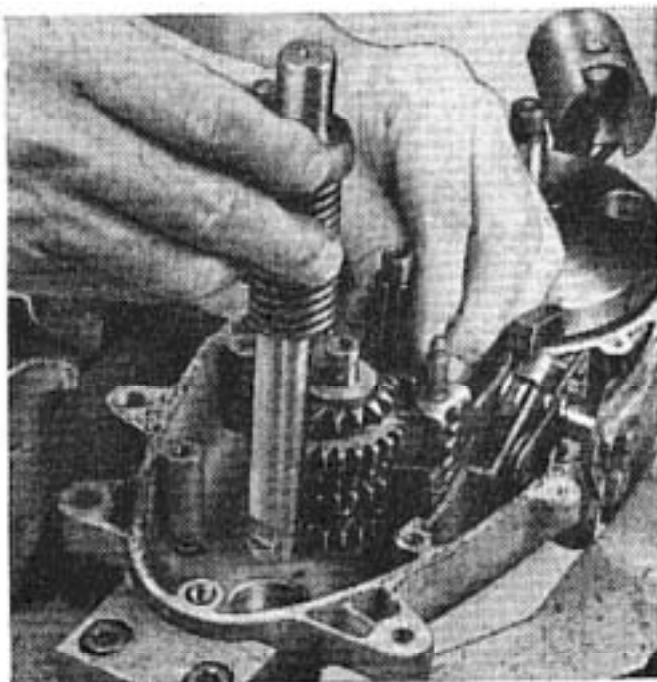

Fig. 22

passing through the crankpin. Both indicator gauges must show readings on the same side of zero, i. e. either both plus or both minus (Fig. 22, -2 and 3). If opposite values are shown on the indicator gauges (Fig. 22, - 1) then proceed as follows:

Determine the highest spot on the crankshaft journal, as marked on the LH journal in the illustration. Using a hammer with a copper head, administer a blow of proportionate force to the flywheel at this spot (arrow A, Fig. 22 - 1).

If, however, the readings of both gauges are on the same side of zero and exceed $\pm 0,01$ mm, adopt the procedure shown in Fig. 22 - 2 and 3. If a minus reading is obtained (measuring always on the crankshaft journal opposite the crankpin), hit the flywheels to force them inwards as shown by arrows B in view 2.

If a plus reading is obtained force the flywheels apart using a lever inserted between them as shown in fig. 22 - 3.

To extract bearings. Both the crankshaft journals are supported by similar bearings in both the crankcase halves. The ball bearing (31 in Fig. 17) is fitted to the inside of the casting and secured on its outer side by a Seeger circlip 33 and a Gufero sealing ring (29) is fitted. To renew bearing (31) first remove the sealing ring (29) and clip (33) and using a drift tube of the same diameter as the outer diameter of the bearing, force the bearing toward the inside of the crankcase. Fig. 24 shows how this is done with the aid of special extractor N 15, N 16 or N 17. The bearing must always be driven inwards when being removed and pressed outward from inside when being fitted in order to protect the retaining clip grooves.

The mainshaft of the gearbox is supported in the LH engine block half by bearing (31) which is of the same size as the crankshaft main bearings. This bearing is also removed by inward pressure after removal of the securing clip on its outer side. The gearwheel with boss is supported in the RH engine block half in bearing (32) and on the outer side it is secured by a Seeger circlip (34) and sealing ring (30). After removal of the sealing ring (30) and the circlip (34) drive the bearing inward to free it from the housing.

Fig. 24

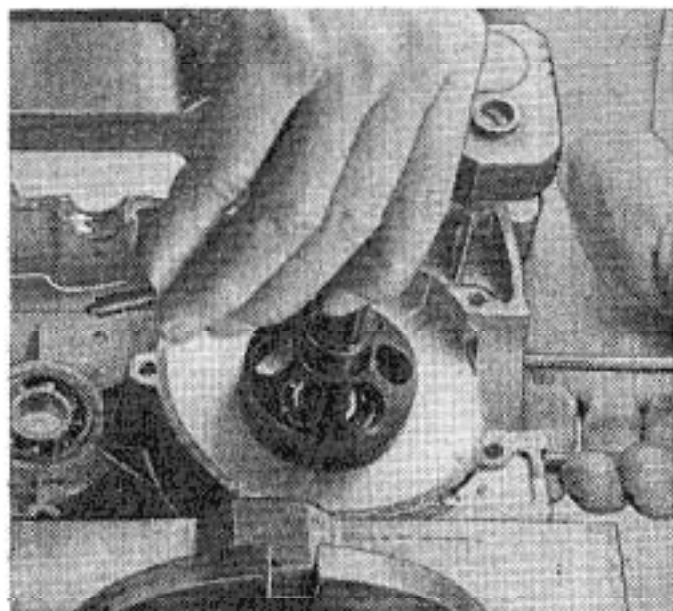

After removal of the crankshaft assembly from the crankcase half it will occasionally be found that the bearing remains on the journal. In such an event it should be removed using an extractor. Should the bearing of the gearwheel with the boss remain on the wheel, wash it clean and test for play. If it is due for renewal, clamp the wheel in a vice using soft jaw clamps to grip the wheel by its teeth and remove the bearing with an extractor. Should such an aid not be available, the bearing may be prised off with a large screwdriver. If the bearing is found to be in order, press it into the casing with the wheel during reassembly.

Rebushing. Two bushes support the layshaft (2 and 3 in Fig. 17) and they should be driven out using a drift tube of the outer bush diameter only if due for renewal. After the new bushes are pressed in place, they must be reamed out to dia $11 + 0,027 - 0,000$ mm. When renewing the disengaging cam bush (5a) in the RH housing, ream out the inside diameter of the bush after pressing in place to $12 + 0,070 - 0,000$ mm.

Assembling the engine

Before assembling the engine, all parts must be thoroughly washed in petrol and dried. The joint faces of both the engine block halves and of the engine side covers must be cleaned by careful scraping. All parts must be inspected and renewed if damaged or worn. Make a point of using only makers' genuine replacement parts. Should one of the two engine block halves be damaged, both must be discarded and two new halves used, for the manufacturers machine and supply the parts in pairs only.

Before assembly, place the parts on a clean sheet of paper laid out on the workbench. All moving parts such as pins, journals and shafts, gearwheels etc. should be lubricated during assembly.

The correct procedure:

1. Both engine block halves are stripped, only bushes are in place.
2. Fit Seeger circlips securing bearings into both halves.
3. Heat both the engine block halves to about 70 to 80 deg. C (160 to 175 F) by indirect heating in hot air.
4. Fit all ball bearings until they seat properly against the circlips. If necessary, drive them home with care using a tubular drift of the same diameter as the outside bearing ring.
5. Fit the crankshaft and the 24-tooth gearwheel with boss into the RH engine block half housing heated as described above.
6. Fit the footchange selector mechanism into the housing formed in the RH engine block half, lodge its rear part in the cut out portion of the protrusion and secure from above with the securing bolt. (Before fitting set at "extra" neutral position between 2nd and 3rd gear.)
7. Fit the starter lever shaft with the quadrant and the return spring, and anchor the end of the spring in the appropriate hole in the RH engine block half.
8. Fit the starter lever to the end of the shaft and secure it by the cotterpin with spring washer and nut.
9. Fit the layshaft to its RH bush in such a manner as to mesh the teeth of the 3rd gear wheels.
10. Fit the 2nd speed - (19 tooth) gearwheel - on the layshaft, dogs facing left.

11. Fit the gear engaging fork into its hole in the selector mechanism and slip it into the annular groove of the layshaft 2nd gear pinion and slip the 2nd gearwheel (19 teeth) over the fork, dogs facing right. Both the pinions (mainshaft and layshaft) of the 2nd gear are identical and no trouble will result if they are interchanged.

12. Fit the guide rod into the fork and the RH engine block half aperture with its smaller-diameter end facing left.

13. Fit the mainshaft into the 2nd and top speed gearwheels.

14. Fit the low gear pinion to the layshaft (24 teeth) (the hub of this wheel is also fitted with the 14 tooth starter gear).

15. Check engaging fork for correct clearance in the grooves of the 2nd speed gears. Rotating the shaft, check the correct operation of the gear selector mechanism and inspect gears for correct meshing.

16. To set the desirable amount of end float of the gearbox shafts, fit the appropriate shims before replacing the LH engine block half to the LH ends of either both shafts or only one of them. The correct location of the shim or shims must be noted during dismantling and great care should be taken to replace them exactly as they were.

17. Apply a thin layer of jointing compound to the RH engine block half joint face and fit the heated LH engine block half. Tap gently around the periphery of the LH half interposing a wooden block between the hammer and the casting until both halves mate properly. The distance separating both castings must be kept even over the periphery during this operation and care must be taken to keep the joint faces parallel at all times. Before the halves touch, depress the starter lever forward in order to ensure proper seating of the pin projecting from the side of the starter quadrant against the stop formed by a protrusion on the inner side of the LH housing half. Also make sure that the engaging fork guide rod fits correctly in the LH half hole with its stepped end.

18. Taking great care fit all the bolts connecting the two engine block halves. They are of various lengths and each length must be fitted to its appropriate hole. The footchange mechanism should be attached to the LH engine block half casting by means of the bolt fitted from above.

19. Finally force both lug bushes into the engine bolt bosses on the engine housing.

20. Fit the Gufero sealing ring over the splined boss extension of the top speed gearwheel outside the ball bearing, after which fit the gearbox sprocket. Then replace the tabwasher, fit and tighten sprocket retaining nut. Finally, after tightening the nut properly, secure it by turning the washer tabs outward.

21. As a temporary measure fit the gear lever pivot stud.

22. Fit the gear selector tie rod in the appropriate holes in the selector arm and the gear lever arm and then slip the gear lever over its pivot stud without securing it.

23. Rotate the gearbox sprocket and engage all gears in turn, check the gear mechanism once more for flawless operation.

24. If gear mechanism operation is satisfactory, remove the gear lever and tie rod and carry on assembling.

25. Fit rubber sealing rings outside the crankshaft main bearings, pushing them inward until they bear

against the bearing retaining Seeger circlips. Take care to fit the seals facing the correct way.

26. Replace the primary transmission, i. e. the clutch hub with chainwheel and the engine sprocket with the primary chain fitted to the sprocket and clutch chainwheel.

27. Drive the engine sprocket fully home and secure by spring washer and retaining nut.

28. Fit the clutch outer plate and the clutch springs which go over the three studs, fit the washers and secure them with circlips. To fit the circlips into their grooves, compress the springs and their washers using a lever.

29. Remove the rear engine bolt (gear lever pivot stud) and depressing the kick starter lever check the primary transmission. Note if the crankshaft assembly will rotate freely.

30. Fit the LH engine side cover gasket and the cover, tighten all the attachment screws with care.

31. Then fit the gear lever pivot stud with a spring washer under the bolt head and tighten.

32. Fit the gear lever and its arm and tie rod to the protruding end of the pivot stud bolt.

33. Fit the plain washer over the pivot end and secure it together with the gear lever by replacing the circlip.

34. Now replace the piston, cylinder barrel and head.

35. Fit the piston heated to about 70 to 80 deg. C (160 to 175 deg. F) over the connecting rod, press the gudgeon pin into its holes in the piston and the bush in the connecting rod eye and secure it from both sides with wire circlips which must expand properly into their grooves.

36. Fit the piston rings with the gaps over the locating pegs in the grooves and fit the cylinder-to-crankcase joint gasket.

37. Fit the cylinder barrel over the piston and the cylinder studs, then replace the head gasket and finally the head.

38. Fit the head washers and nuts, tighten evenly and fit and secure the carburetter to the carburetter flange.

39. Then proceed refitting the components of the RH assemblies.

40. Press the 4 mm dia. pin securing the magneto rotor against movement on the crankshaft journal into its hole.

41. Fit the rotor and cam over the taper section of the shaft extension. Correct cam timing is assured by the tongue which mates with the slot formed in the inside diameter of the cam.

42. Fit the M5×55 retaining bolt to secure the rotor and cam to the shaft extension. A spring washer goes under the bolt head.

43. Replace the stator and attach it by two M5×30 bolts with spring washers by means of two holders which fit into slots cut out in the yoke periphery.

44. Remember to insert the clutch disengagement pin into the hole drilled in the mainshaft of the gearbox from the RH side. Fit the engine into the frame.

45. After securing the engine, connect the two leads to the terminal panel and one lead to the contact breaker.

46. Check for correct contact breaker gap and time the ignition (set ignition advance).

47. Finally fit and secure the RH engine side cover.

The Cycle Parts

Both the Jawa 550 and 555 models employ basically similar cycle parts, the modifications for the latter consisting of reinforced wheels, an improved front mudguard, a tail fairing in place of the previously used unsprung rear mudguard and the addition of a second coil spring at the upper end of the pivoted rear sub-frame. All tasks involving differing procedure for the two models are described separately for each model.

To detach front wheel (Fig. a). Remove the spindle nut (29) and washer (30). Loosen the pinch bolt contracting the spindle eye at the lower end of the unsprung LH fork member on model 555 machines and withdraw the spindle (28). Slide the wheel out of the fork members and remove the brake anchor plate (17). The wheel can then be completely removed and the back plate remains on the machine, suspended by the control cable. This applies also to model 555 machines.

To detach rear wheel (Fig. b). Remove the spindle nut (28) with its washer (29), withdraw the hub spindle (49) and remove the torque reaction member (27). The correct method is shown in Fig. c. The member must be removed toward the rear and must not be refitted in reverse position, for the studs on the brake plate and the pivoted sub-frame are of different diameters. On model 550 disconnect the rear chain. Slide the rear wheel off the sprocket studs (this concerns model 555), remove the brake anchor plate and the wheel is free for removal. For wheel alignment the use of gauge P 18 is recommended.

To dismantle brakes (Fig. a). This description relates only to 555 models which employ more complex and fully interchangeable wheels. After removal

of the brake anchor plate (17) from the brake drum, expand the shoes (20) and slide them sideways off the cam and shoe pivot. This opens access to the cam arm (24) which is attached on the inner side of the anchor plate (19) under the shoes (20). Press the arm (24) upwards at its free end and disengage the control cable nipple which is slack in the arm after forcing the free end upwards. For control cable renewal, first unscrew the adjustment screw on the outer side of the anchor plate in order to permit the nipple to pass through the hole in the anchor plate.

To remove wheel bearings (Fig. a). Identical hubs are used for both wheels on the 555 model and bearing removal is therefore similar in both cases. Remove the three countersunk screws which secure the sheet metal hub side-cover and remove the cover taking care not to damage it. From the LH side remove the seals (10) and the circlip (16). From the RH side remove the dust cover ring (27) and seal (10). By applying pressure to the RH bearing (15) force the LH bearing (15) out of the hub. Then remove circlip (9) and distance tube (8) and apply pressure to remove the RH bearing (15). Wash all parts thoroughly and renew bearings if worn. Before replacing lubricate the bearings as well as the spindle hole through the hub thoroughly with high melting point grease and take care to seat the circlips of the LH bearing (16 and 9) well in their grooves.

To remove rear wheel sprocket of model 555. (Fig. b). If it is only necessary to grease the bearing, remove seals (38) and (39) and grease the bearing. The sprocket can be left on the rear sub-frame. To replace the bearing, disconnect the chain, remove nut (50, Fig. d) and remove the complete sprocket assembly from the sub-frame. Remove seals (38) and

Fig. c

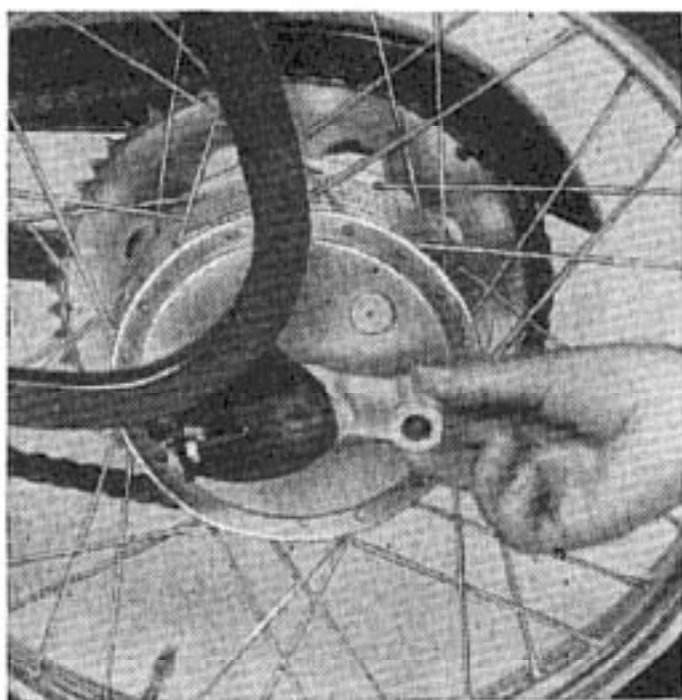

Fig. d

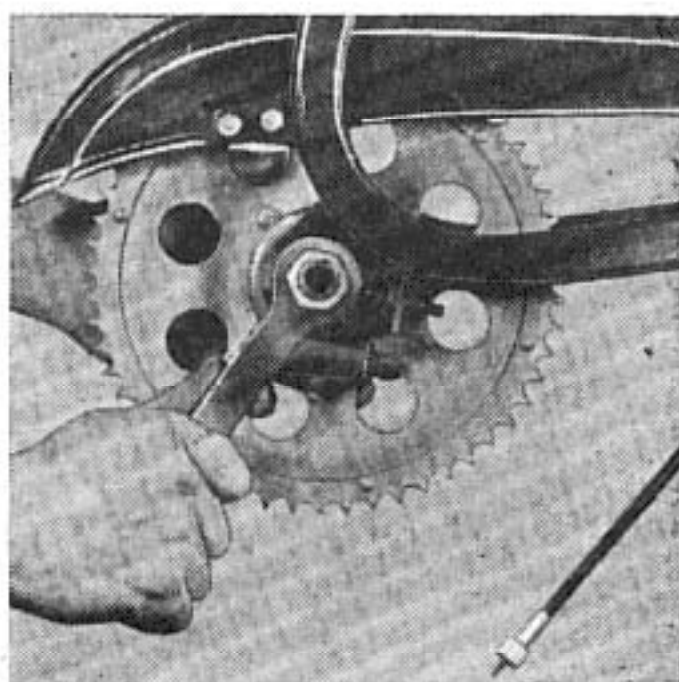
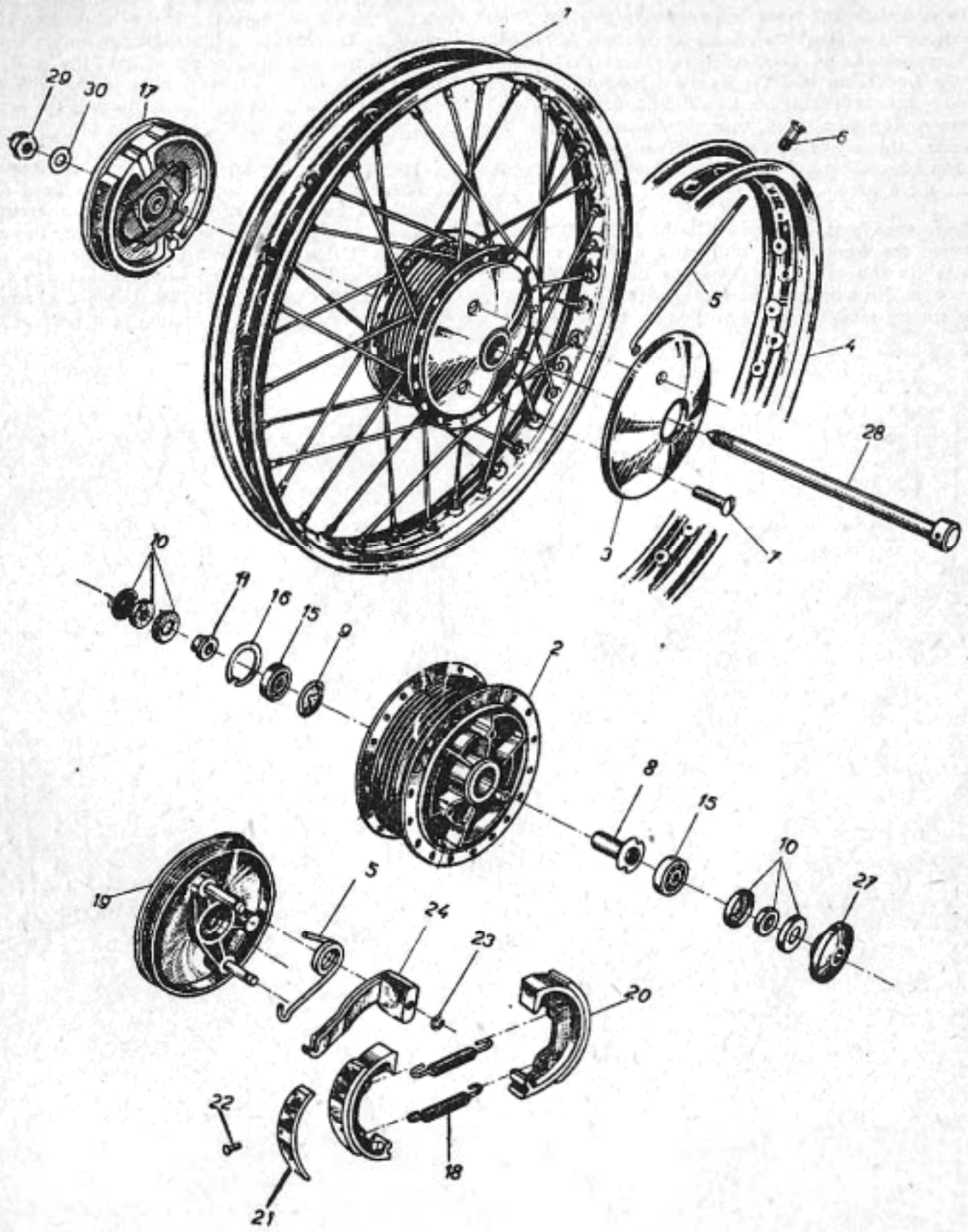

Fig. a



(39), drive out the hollow shaft (31) and remove circlips (34). The bearing can then be extracted. After reassembly check wheel alignment and chain tension. Bearing removal and refitting is greatly facilitated by the use of special extractors N 16 and N 17.

To dismantle the front fork assembly (Fig. e). The components of the front forks of models 550 and 555 are similar in every respect except the shape of the handlebar and the front mudguard. The following instructions stress this difference where necessary. The headlamp assembly arrangement including the reflector, lens and rim follows well-known Jawa-CZ practice and need not be described once more here.

To remove front mudguard. On the Jawa 550 model remove the front wheel and remove the six bolts which fix the mudguard stays to the sliding fork members. No stays are used on model 555, on which the sprung mudguard is attached by two screws to

each fork stanchion. Remove the screws and tilt the mudguard in order to remove.

To remove handlebar. The handlebar may be removed or renewed after disconnecting control cables and electrical wiring. The handlebar is held in place by one bolt with cone nut in pedal cycle fashion. Dismantle the twistgrip for lubrication (use grease) or for throttle cable replacement. In order to remove the twistgrip, rotate it until the counter-sunk screw securing the end plug mates with the hole at the outer end of the grip. Remove the screw and the end plug, then slide the grip off.

To remove the headlamp cowl (Fig. e). Remove the reflector with lens and rim from the cowl and remove the bulb holder. To facilitate further work disconnect wiring and control cables passing through the cowl. Using a screwdriver, unscrew the two screws attaching the switch and another screw in the rear portion of the cowl (12). Using a spanner, remove the two screws (14) in the rear part of the

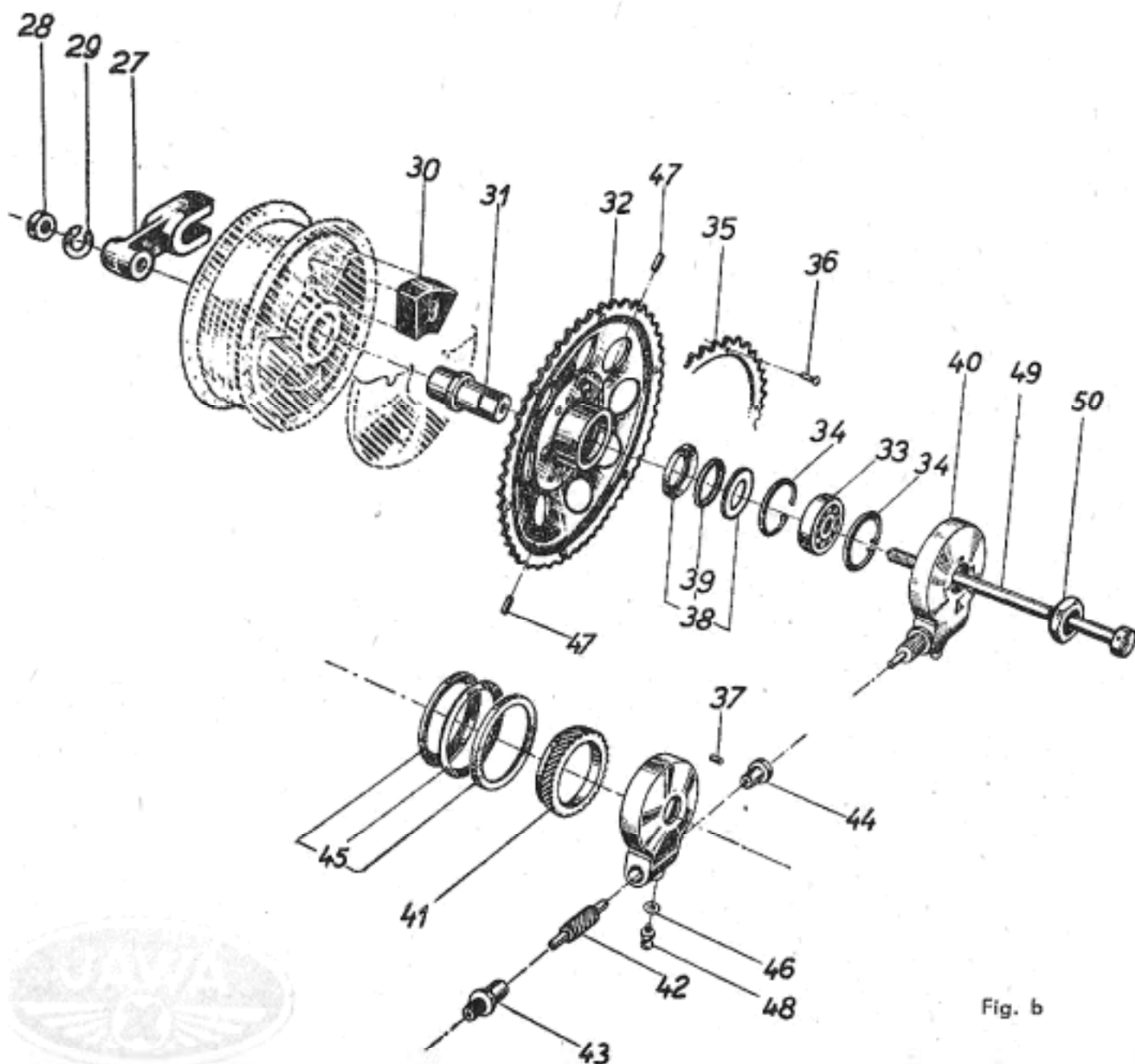

Fig. b

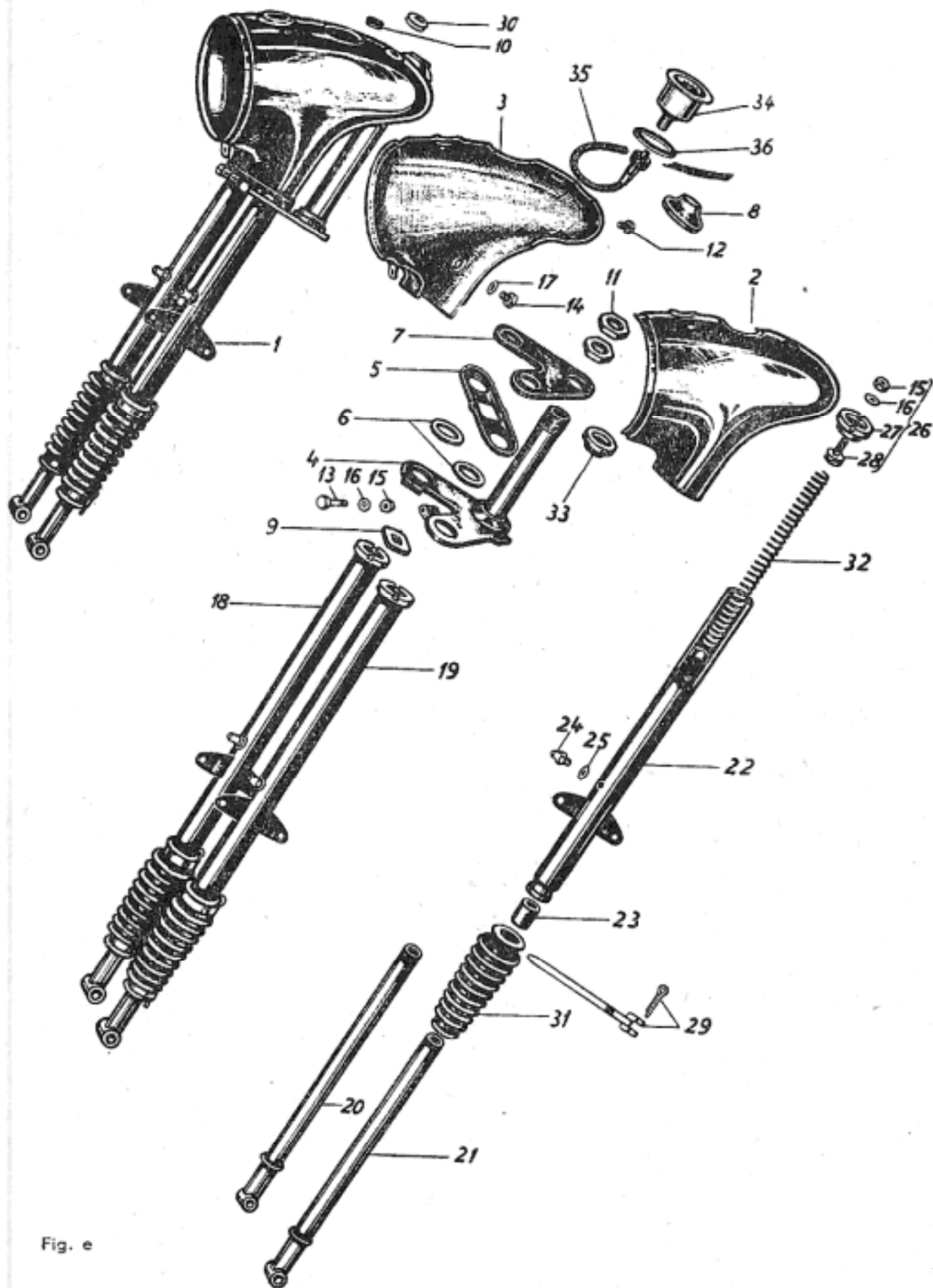

Fig. e

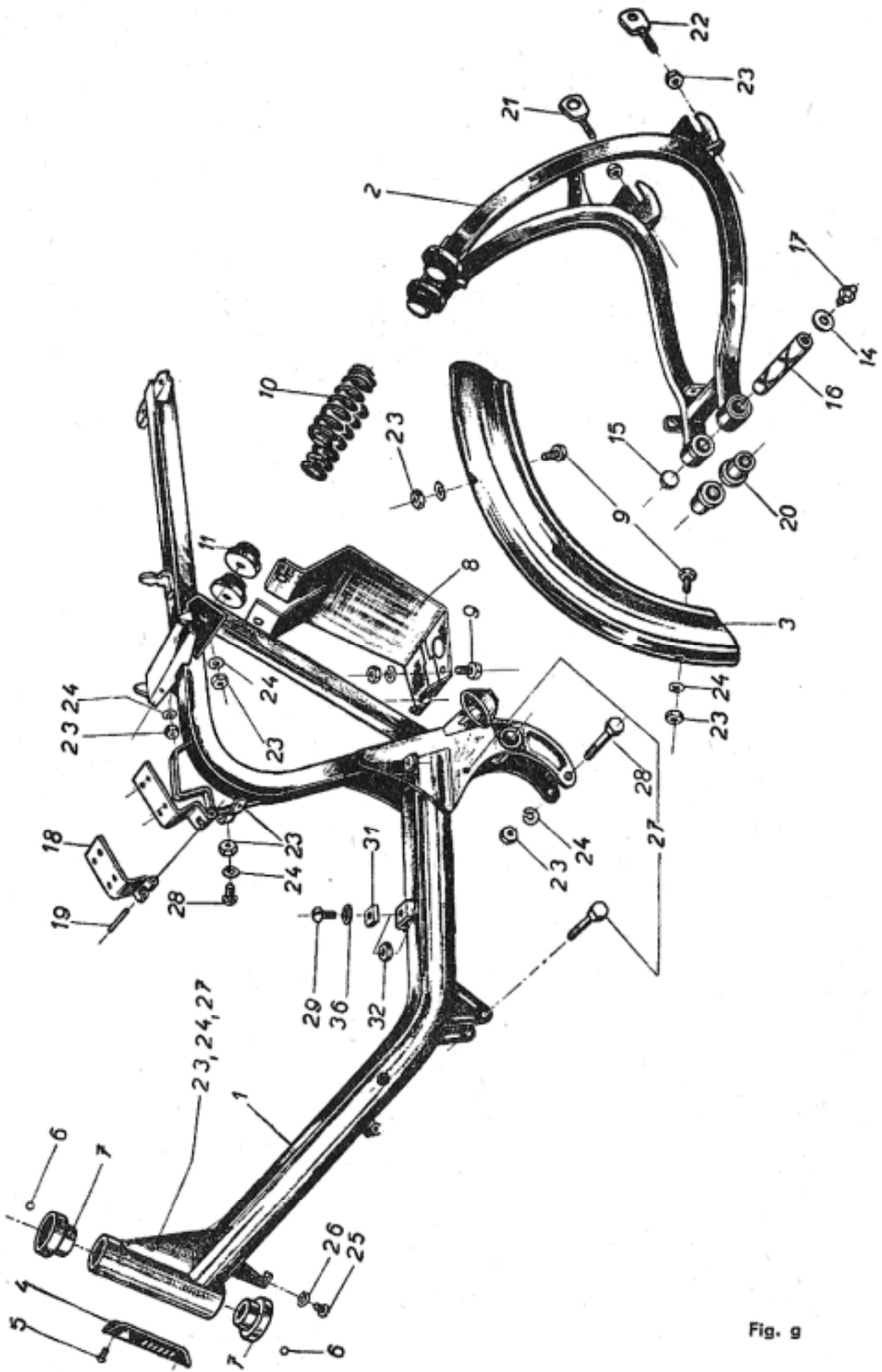
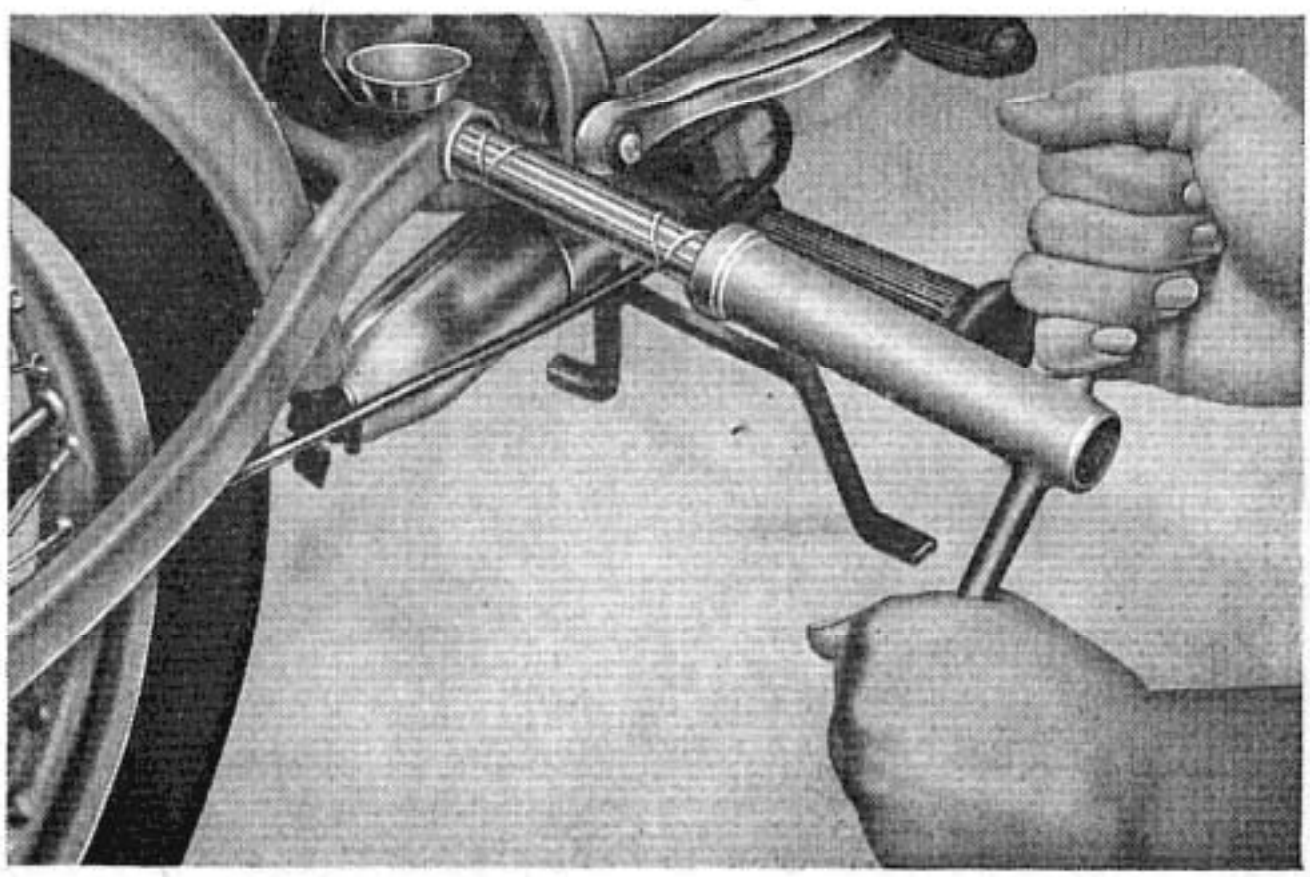
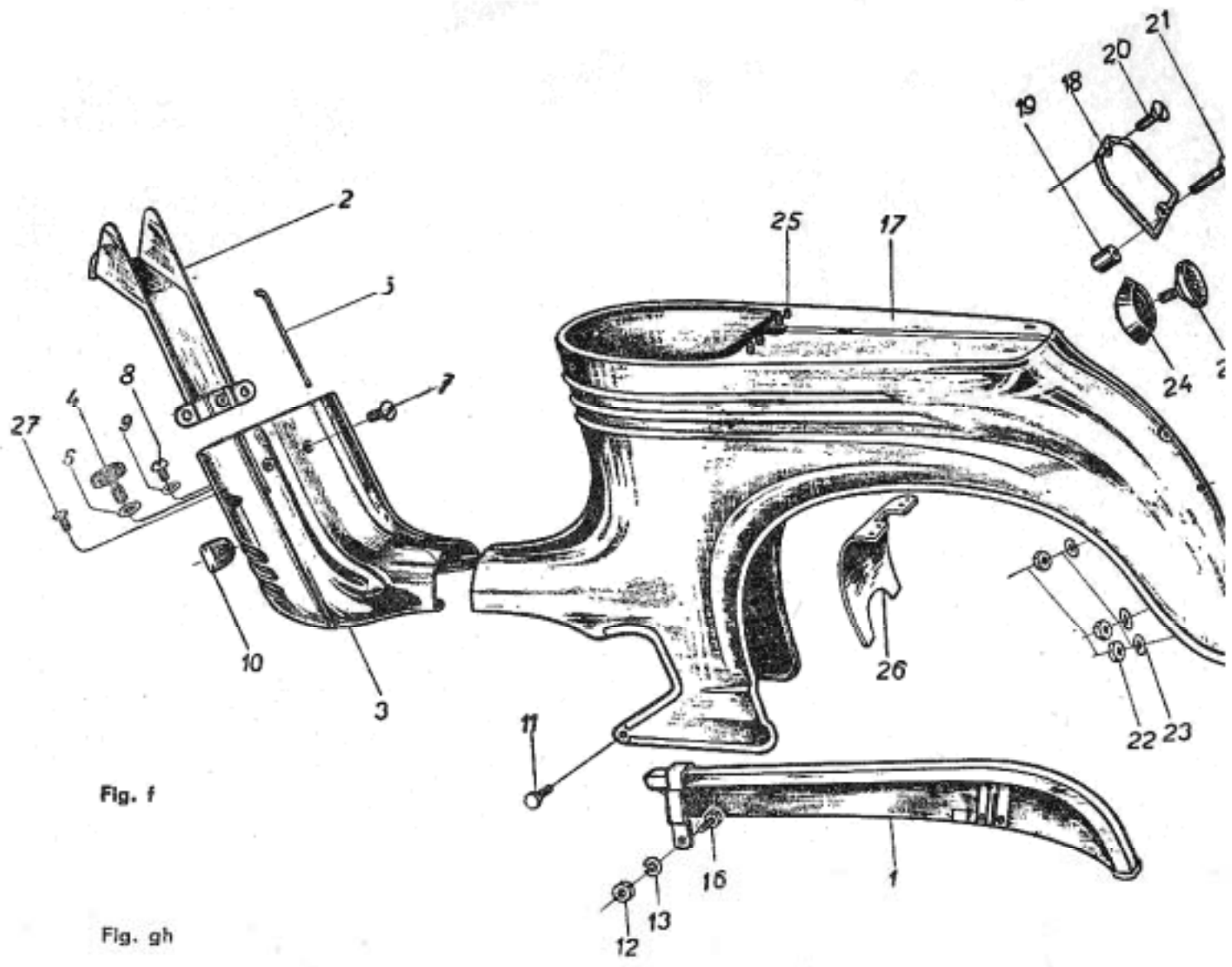

Fig. 9



cowl, above the lower stanchion bracket. Having removed all wiring and cables passing through the cowl, tilt the cowl halves sideways and remove them from the fork. The bottom cowl section (5) can be removed only after detaching the upper stanchion holder (7). This is dealt with in the following paragraph. During reassembly, care must be taken when pulling the wiring and cables through the holes in order to prevent damage to their insulation and casings. Some difficulty may be experienced in locating the two screws (14) above the lower stanchion bracket, for the cowl tends to spring upward and due care must be taken not to damage the threads.

To dismantle the fork (Fig. e). Remove the front wheel mudguard and headlamp cowl, then remove the constrictor band (29) of the rubber bellows (31) and using a tubular spanner, unscrew nut (15) from the upper end plug (27) of the fork stanchion tube (22). Unscrew the upper end plug (27) from the upper end of the stanchion tube. Withdraw the lower fork member (20-21) together with the spring (32) from the stanchion tube in a downward direction. The stanchion tube together with the fork bushes (22) can be removed from the lower stanchion bracket after withdrawing pinch-bolt (13) from the latter. When refitting, remember to lubricate the spring (32) and the bushes (23) inside the stanchion tube. Assemble in reverse sequence and check the fork leg for correct suspension movement after assembly.

To remove front fork from frame (Fig. e). Remove the front wheel, mudguard and headlamp cowl as described above. Remove nuts (15) and both plugs (27). Remove the steering head nut with counternut (11) and remove the upper stanchion holder. Withdraw sheet metal cover (5) and rubber seals (6). Remove the fork by sliding downward, taking care not to lose any of the steering head bearing balls. To assemble proceed in reverse sequence, grease the balls and the bearing races thoroughly and check the assembled steering head for effortless movement. Steering head play is taken up by tightening the steering head nut (11) with its counternut.

Stripping the frame and accessories

The frames of both models are basically similar, the later model being distinguished by a rear wheel fairing attached to the sprung portion of the frame and by dual springs for the pivoted rear sub-frame. Owing to this similarity, instructions for stripping the frames apply to both models and special mention is made of those instances where the procedure differs.

To detach saddle. Release the saddle securing screw on the LH side below saddle (no tool required) and tilt the saddle on its pivot. Disconnect leads from battery cover and withdraw the battery from its holder. Unscrew two M6 screws attaching the saddle pivot holder to the frame on RH side and remove saddle.

On model 555 tilt the saddle forward, remove the saddle pivot holder screws from the upper part of the frame and remove in similar fashion.

To remove rear enclosure panels, model 550. Remove the brake pedal pivot nut and remove the pedal with the brake rod. Remove the screw behind

the engine which attaches the rear frame shield. Remove all remaining screws securing the enclosure panels and remove both panels. The small rear cover protecting the spring is removed last.

To remove rear mudguard, model 550. First release the mudguard stays which are attached by four M6 bolts with nuts to the pivoted rear sub-frame. Then remove the nut from the upper attachment bolt of the mudguard and finally remove the lower attachment bolt, thus releasing the mudguard.

To remove the rear enclosure of model 555 (Figs. g and f). The rear enclosure and fairing on the 555 model is an integral unit and the luggage carrier fitted to this model is attached behind the pivoted saddle. Before attempting to detach it, remove the brake pedal, remove the saddle and disconnect the battery leads. Remove attachment screws of the enclosure near the footrests on both sides (11, Fig. f). From above unscrew the three bolts fixing the luggage carrier and rear fairing to the frame (when refitting do not forget to replace the distance tubes between the carrier and the rear fairing on the two rearmost bolts). Unscrew the remaining two nuts and bolts retaining the upper side of the enclosure on the frame below the saddle and disconnect the tail lamp wiring. The enclosure can then be lifted off the frame. A small panel protects the space under the saddle from road dirt and the last component to remove is the little mudguard (3) held in place by bolts (9) and nuts (23), see Fig. g.

To remove frontal cowl (on either model) - (Fig. f). Remove the front inspection panel screw (4) and the remaining attachment screws, i. e. three below the fuel tank, and one in the middle of the panel above the engine (7) which joins the front and rear enclosure panels. Disconnect the carburetter cold starting pump pull-rod and remove frontal enclosure panel. The front portion of the frame below the fuel tank carries a narrow sheet metal shroud (2) protecting control cables and wiring from the handlebar and to the headlamp. Remove the shroud by releasing one screw at its upper end and two in its lower portion.

To remove the fuel tank (on either model). Disconnect the fuel hose to the carburetter, drain the tank and unscrew and remove the fuel tap. Unscrew the nut of the upper tank bolt and remove the bolt. Remove the lower tank bolt which also attaches the ignition coil.

To remove the chainguard (on either model). The chainguard is attached to the RH chainstay of the pivoted sub-frame by two bolts at the rear and one at the front (16 - Fig. f).

To dismantle rear pivoted sub-frame (on either model, Fig. d). The rear pivoted sub-frame describing an arc about the pivot in the rear part of the frame proper is similar on both models. On the older model 550 one spring is fitted to the upper frame part, whereas on model 555 two springs are fitted in the same location. Dismantling is easy, but a special tool is needed to extract the hollow pivot pin. The employment of this tool is shown in Fig. gh.

Remove the rear enclosure and the wheel and release the spring (two springs on model 555). Unscrew nuts (23) from the upper bolt attaching the

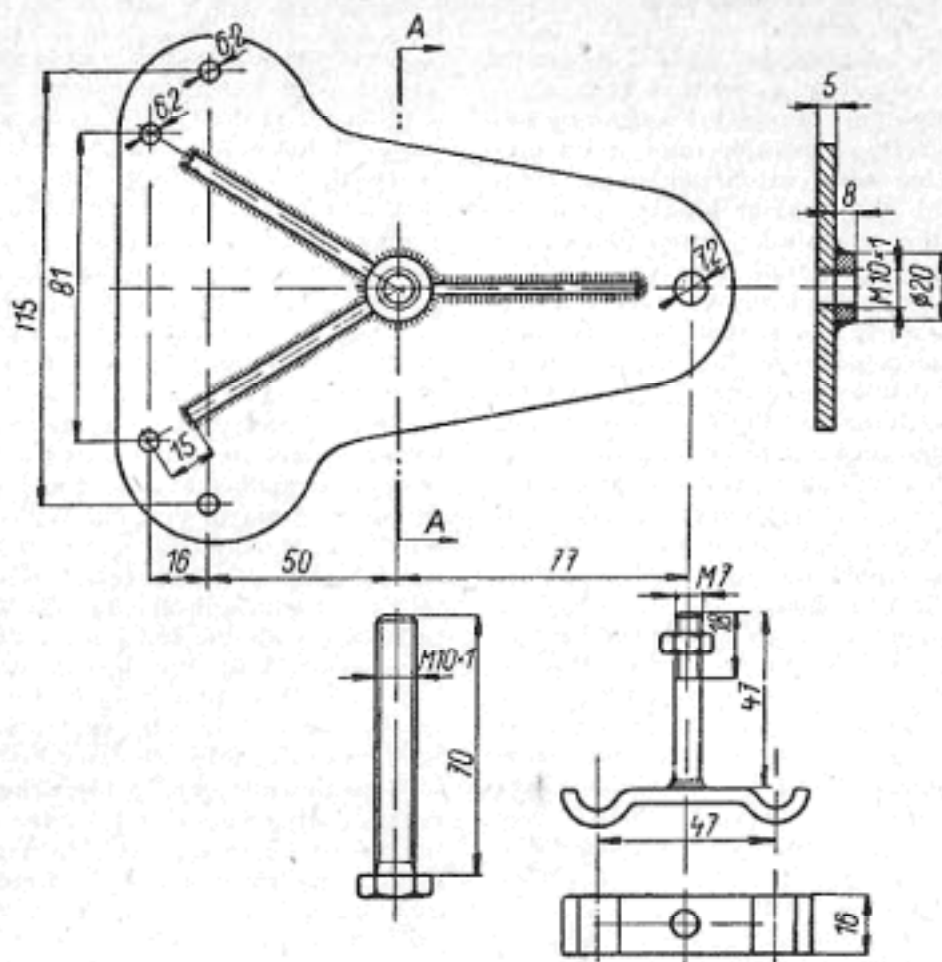

This is the tool for splitting the engine and separating the two halves. It can be made by amateur owners. Other special tools may be substituted by universal extractor or other tools which are available in all workshops.

spring carrier to the frame, withdraw the bolt together with the spring carrier from the hole in the frame and the rear sub-frame will then swing down about the pivot. The same bolt also fixes the bottom panel of the space under the saddle, which is also attached by two M6 bolts and nuts in its lower portion. Never resort to hammer blows to drive out the pivot pin, use nothing but the special extractor.

The correct procedure:

Unscrew the lubricating nipple from the LH end of the pivot pin. Into the thread of this nipple screw either a suitable screw or tool N 45 in order to remove the LH cover (Fig. 8).

Using a drift passed through the hollow of the pivot pin drive out the other end cover. To remove the hollow pivot pin use tool P 22 on model 550 and tool N 10 on model 555. Worn pivot bushes should also be extracted and after fitting, new bushes must be reamed out to dia. $18 \text{ mm} + 0,027$.
- 0,000

Assemble in reverse order, grease the pivot pin and bearing surfaces of the bushes as well as the frame lug beforehand. Spring washers must be properly replaced and nuts fully tightened. Check the suspension movement after fitting the sub-frame to make sure the suspension has been properly assembled.

Electrical Equipment

Electric energy is supplied by the AC magneto-generator with an output of 20 watts, 6 volts. Both the ignition and lighting systems are served by the magneto-generator. The generator rotor is an aluminium alloy casting with cast-in permanent magnets. Together with the contact breaker cam the rotor is fitted to the crankshaft journal pin. Inside the generator yoke (the stator), four coils for the lighting equipment are fitted and connected to terminal 55. In addition to these, there are also four ignition coils, connected to terminal 31. On generators with ALNICO alloy permanent magnets each ignition coil has 42 turns and the overall resistance of the whole winding amounts to approx. 1,35 ohms. On machines with ALNI permanent magnets there are 47 turns and an overall resistance of 1,45 ohms. The ignition coils are of 0,8 mm wire, the lighting coils have 72 turns of 0,85 mm wire each and their overall resistance is 1,65 ohms.

The magneto-generator requires no special attention, but the contact breaker gap should be checked at regular intervals, the felt lubricator oiled occasionally, and the terminals checked for tightness of the grub screws etc. During work on the generator care must, however, be taken to minimise loss of magnetism of the permanent magnets. When stripping the magneto-generator always replace the detached rotor immediately into the yoke or secure a mild steel band around its periphery. If reduced output of either ignition or lighting windings is suspected, measure their voltage on the magneto-generator terminals. At 4000 engine r. p. m. an AC voltmeter should show over a range of 12 to 30 volts. Remove the windings if found faulty. A reduction of ignition or lighting coil voltage can also be caused by partial loss of permanent magnetism, in which case a sufficiently powerful spark is produced

by the ignition circuit only at increased engine revs. To check for loss of permanent magnetism connect a voltmeter to the lighting coils, switch on the head and tail lamps (15 and 5 watts respectively) and speed the engine up to 4000 r. p. m. when the reading should be $6 \pm 0,4$ V. To obtain the correct engine speed of 4000 r. p. m. engage third gear and accelerate the engine until the speedometer needle reaches approximately 37 km p. h. (23 m. p. h.). The permanent magnets may be remagnetised at a specialist workshop owning magnetising apparatus.

The relation between engine speed and generator voltage is shown in Fig. h. 50 c. c. Jawa machines of early manufacture used the layout shown in the wiring diagram in Fig. ch. With this arrangement, tension at terminal 55, and thus also at the bulbs, at high engine speeds (above 4000 r. p. m.) is the following: with only the 15 W/6 V bulb lit 10 to 12 volts; with only the tail lamp bulb (5 W/6 V) lit, 16 to 20 volts. With this layout there was a risk of burning out the remaining bulb whenever one filament burnt out or whenever the dipswitch or the lighting cables failed.

The wiring diagram in Fig. i. relates to machines supplied after February 1959. The installation incorporates a choke coil (10) in the lamp circuit to protect the remaining bulb from overload if one bulb burns out or if one bulb does not light up owing to a faulty switch or as a result of incorrect connection. The choke coil incorporates two windings arranged in opposing directions. The first winding, with the start connected to the main bulb lead has 43 turns of 0,75 mm wire, the second winding, the end of which is connected to the tail lamp bulb is made up of 125 turns of 0,4 mm wire. The start end of the first winding and the start of the second winding are both connected to terminal 56. The choke coil core is of transformer sheet E 12 and I 12.

If it is intended to improve the equipment of one of the machines of earlier production by incorporating the choke coil in the circuit, fix the coil inside the headlamp cowl by two M3x6 bolts with nuts. The red cable from terminal 56 on the lighting switch

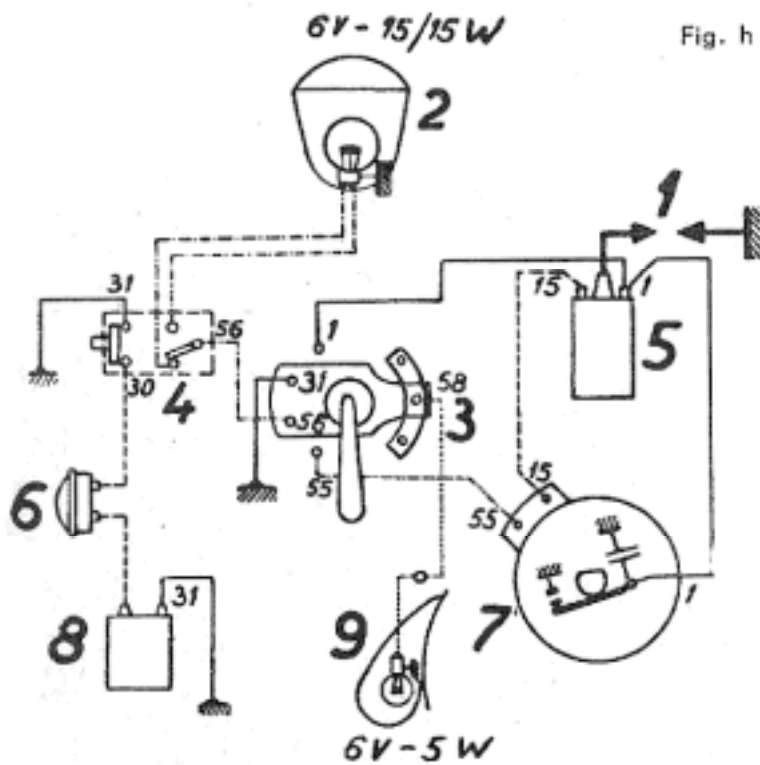
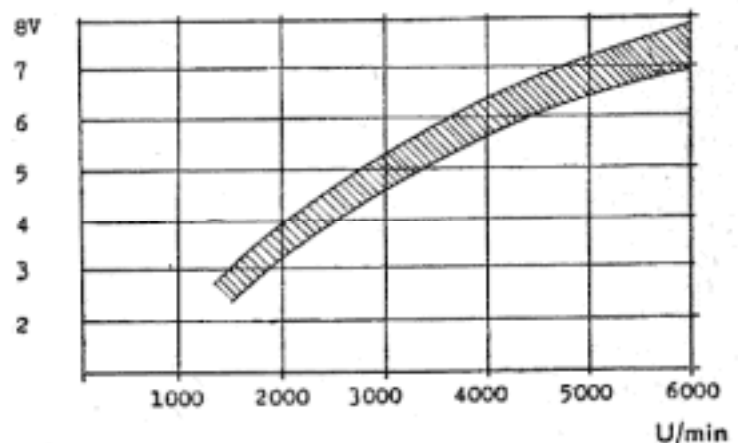

Fig. h

Fig. ch



should be connected to terminal 56 of the choke coil. Remove the yellow cable 58 from terminal 58 of the switchbox and connect it to terminal 58 on the choke coil. Using a new cable of about 120 mm length (5 ins), connect middle terminal 55 of the choke coil with terminal 56 of the lighting switch.

The bulbs can, however, be protected against overload without fitting a choke coil if wiring diagram shown in Fig. J is followed. Disconnect the yellow cable from the lighting switch from terminal 58 and connect it to one of the terminals under the main bulb. Then take a new cable of equal length, connect to remaining terminal under main bulb and the other end to the rear bulb carrier. This new cable should run along the yellow cable. The rear bulb holder must be removed and insulated from earth before refitting. The reliability of the lighting connected in this manner depends on the interconnecting cables which should be inspected for chaffing or breakage etc.

The high tension coil and spark plug require no extra attention both must, however, be protected from blows during assembly. Keep the surface as well as the points of the spark plug clean. The manufacturer recommends the use of PAL 14/175 plugs, but other plugs of equivalent grade may be fitted. Also keep the condenser surface clean during assembly to prevent possible unreliable contact with the yoke, or short circuits between the metal casing and the cable end.

Lighting. The headlamp bulb is of the twin filament type, 15/15 W, 6 V. The beam angle is readily adjustable by tilting the reflector after loosening the knurled nut at the top of the headlamp rim. A 5 W, 6 V bulb is used in the tail lamp.

Audible warning device. Machines of the older type are fitted with an electric horn attached to the frame below the fuel tank. Current is supplied by a dry battery stored under the saddle. To adjust the sound of the horn rotate the screw on its rear side. If the desired effect is not obtained by this, detach the cover plate with the inscription PAL and adjust by means of the screw found in the centre portion of the front part of the horn and secured by a counter nut.

On machines of the new model, an AC buzzer is fitted, with a connection to the generator cable terminal 55 in the lighting switch. The other terminal of the buzzer is connected to the buzzer ("horn") button in the dipswitch unit on the handlebar. The sound volume of the buzzer is adjusted by the forward facing central screw in its front side. When main lights are on, generator output is insufficient to make the buzzer sound. Owing to this intentional feature the rider is forced to give warning of his approach by flicking the lights at night, which is required by the regulations in the majority of countries.

Electrical cables. Only cables of 1 sq. mm section should be used. To facilitate identification, various colours are used by the makers. Repair chafed cables with insulating tape or renew.

.....	yellow cable
- - - - -	red cable
— — — — —	blue cable
— · — · — ·	white cable
—————	black cable
- - - - -	green cable

Fig. i

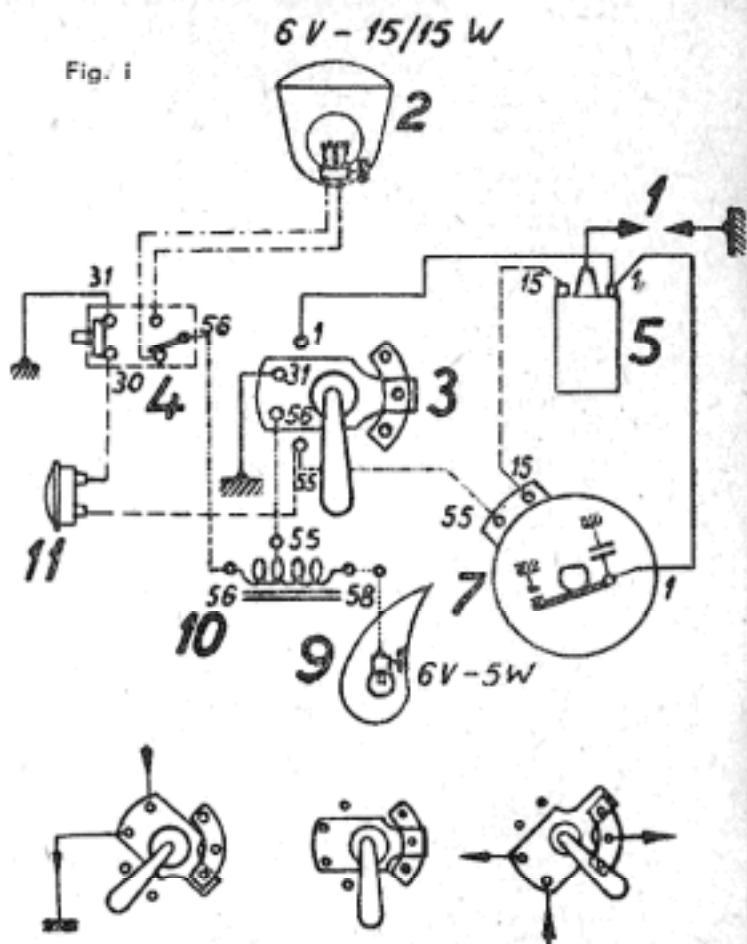

Positions of the headlamp-cowl-mounted switch. Left: ignition off (to stop engine), middle: riding in daylight, right: riding at night.

Fig. J

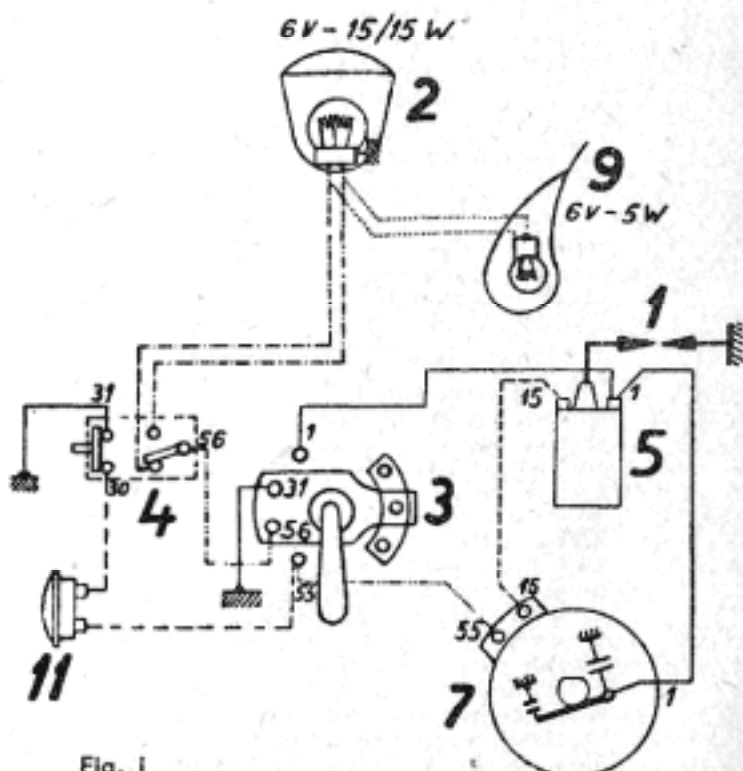

Faults and Remedies

Reduced engine performance

- a) Incorrect ignition timing, untrue cam resulting in double contact breaking. Symptoms: engine will not accelerate to peak revs., four-stroking. Set the correct ignition timing (2,8 to 3,1 mm advance) and if necessary, replace the contact breaker cam.
- b) Air leaks — possible sources: the carburettor-to-engine joint, the crankcase middle joint or the RH Gufero seal on the crankshaft. In the first named instance renew gasket or tighten bolts. In the second, grind crankcase joint faces to bed down to make gastight joint. The last named fault is remedied by fitting a new Gufero seal to the RH crankcase half.
- c) Oil pumping into crank chamber of engine block. Symptoms: very smoky exhaust and repeated plug oiling. Causes: faulty seal between engine block halves or oil pumping into crankcase via the LH crankshaft Gufero seal. Remedy: regrind joint faces of crankcase halves and renew seal.
- d) Engine overheating. The probable cause is a blocked exhaust silencer which must be cleaned. Faulty ignition timing may also be a cause.
- e) Engine knock — sluggish engine acceleration — irregular firing. Probable causes: incorrect carburettor setting, blocked jet or gauze fuel filter. Clean carburettor and tune.
- f) Reduced engine performance — reduced compression ratio. Probable causes: worn cylinder bore, worn piston rings. Fit new rings or rebore cylinder.
- g) Leaking cylinder head joint. Tighten head nuts or replace gasket.
- h) Brake drag. Possible cause: brake lining in constant contact with the brake drum. File down the lining and readjust brakes.
- i) Regular engine running, but a noticeable drop in engine performance on slight gradient in top gear. Check the gearbox sprocket. If a 14-tooth sprocket is fitted, replace it by a 13-tooth sprocket.

Ignition.

Engine will not reach high revs. — irregular firing — "four-stroking".

- a) Defective condenser, fit new one.
- b) Condenser cable eylet making contact with earth — fit in correct attitude.
- c) Low tension cable eylets on high tension coil touching frontal enclosure panel. Fit in correct position, insulate with tape if necessary.

The gear box — gear selection.

- a) The upper part of the gear lever abutts against the engine block and prevents gear selection. The cause: using force in gear changing, which results in a bent lever. Straighten lever.
- b) Deformation of footchange mechanism cam plate as a result of using force when changing gears. Gears cannot be selected as a result and the cam plate must be straightened.
- c) Stuck ratchet pawl on selector mechanism. Gears cannot be selected. Clean the pawl housing, pawls must be free.
- d) Jumping out of gear. If low and top gear jumping is experienced, possible causes are misalignment of the selector mechanism or damaged dog studs on the 19-tooth gearwheel. The edges of the mating holes of the gearwheel with boss may be badly worn. Misalignment of the selector mechanism is caus-

ed either by an offset groove in the housing into which the mechanism fits or by deformation of the mechanism itself. Inspect the stripped gearbox for any traces of these faults. Renew gearwheels with badly worn edges and mating holes. Modify the selector mechanism in the following way: Undercut the cam plate teeth by grinding out for each gear as shown in Fig. k.

If jumping out of first gear is experienced, undercut the first tooth from left on the outer side by 0,8 to 1 mm. If jumping out of top gear is experienced, undercut the first tooth from the right on the outer side by 0,8 to 1 mm.

If jumping out of second gear is experienced, check the splines on the shafts for wear and renew if edges are worn. Undercut the middle tooth of the cam plate by 0,5 mm on each side.

In case of fall out of gear shifts we can also use a stronger spring, supplied with spare parts under the number 550-24.135.

- e) Knocking noise in the gearbox when neutral is engaged. The probable causes: bent selector fork, loose pivot pin or bent cam plate. Straighten the cam plate or renew faulty components.
- f) The starter lever offers no resistance when depressed, will not engage. The cause lies in a seized ratchet which remains in disengaged position. Dismantle the ratchet mechanism and remove possible burr on bush.
- g) Seized starter lever. Caused by worn starter quadrant teeth. Fit new quadrant.

The Clutch

Clutch slip. Adjust for clutch wear and resultant slip by turning adjuster screw on engine cover. If clutch slip is experienced despite correct adjustment

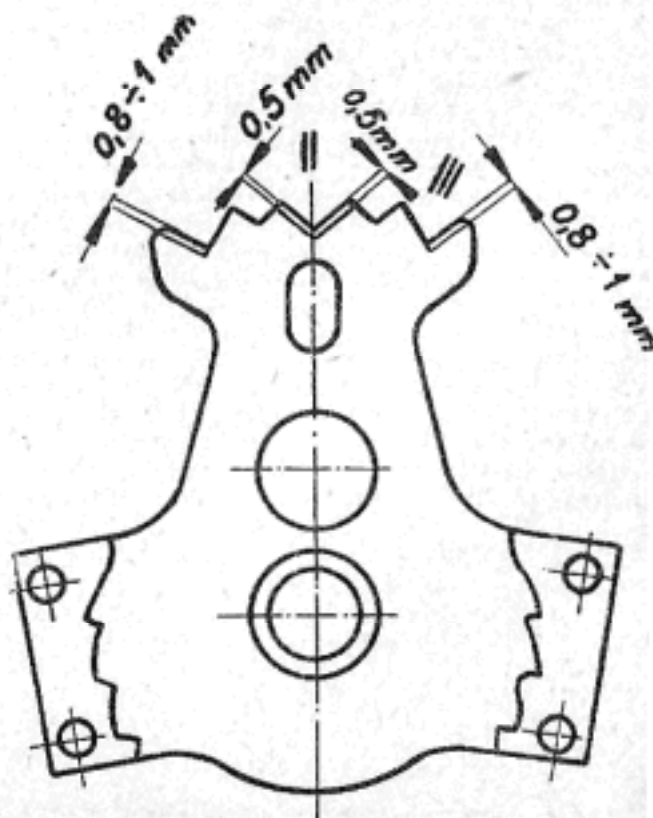

How to modify the gear selector cam plate.

(check at handlebar where there must be backlash in the clutch cable, i. e. free movement of the handlebar clutch lever) then further withdrawal of the disengaging pin will bring no improvement. Inspect the cork-lined clutch plates, some of the cork inserts may have become unseated or the lining may be badly worn.

Renew cork inserts.

Spring fatigue is another possible cause of clutch slip. This is remedied either by fitting extra washers under the springs or by fitting new springs.

Clutch drag.

This is caused by a seized disengaging pin. Fit a new pin and ensure that it is lubricated together with the adjacent ball at regular intervals.

Scraping and whining noises from engine.

Noisy gearbox operation.

The probable causes:

- a) Too little oil or none at all in gearbox. Fill to prescribed level.
- b) Worn bearing in crankcase or gearbox produces a characteristic sound. Fit new bearing.
- c) Dry cam produces whistling sound.
Oil the felt lubricator and ensure that it makes contact with the cam lobe.

- d) Generator rotor scraping against yoke.
Clean the taper hole in the rotor hub and the taper section of the crankshaft journal. Tighten the rotor properly.
- e) Primary chain out of alignment. The engine sprocket is not in the plane of the clutch sprocket. Check and align.
- f) Primary chain rubs against housing, loose chain. Fit new chain.

Engine knock.

- a) Loose gudgeon pin (sharp knocks). Fit new gudgeon pin.
- b) Worn big end bearing. Renew or repair.
- c) Excessive ignition advance. Set the recommended 2,8 to 3,1 mm b. t. d. c. timing.
- d) Heavy carbon deposit inside cylinder head, on piston crown and in exhaust passage. Remove carbon.

Frame troubles.

- a) Engine loose in mountings.
Symptoms: Jerky acceleration from rest. Tighten lug bolts.
- b) Rear sub-frame wobble. Renew the pivot bushes.

Tracing and remedy of faults in electrical equipment

A. Ignition faults.

1. The engine will not start or stops suddenly and refuses to restart.

The trouble might be due to fuel starvation, a carburettor fault or faulty ignition. If there is enough fuel in the tank and the fuel supply to the engine is in order, check the spark on the spark plug.

Generally the cause will be in the plug, which may be fouled (oiled) or bridged, the insulator may be damaged or the gap may be excessive. Therefore check the spark with the plug removed from the cylinder head. If no spark is produced by depressing the starter lever or only a weak spark is apparent, check the end of the high tension lead for correct sparking. If the end of this lead produces a good spark against earth, the trouble is due to the plug which should be repaired or discarded. If a weak spark is produced at the high tension lead end, the cause may lie in loss of permanent magnetism. Measure the voltage of the lighting coils of the generator. No spark at high tension lead end.

Possible cause:

Lighting and ignition switch in OFF position!
Faulty contact breaker. Check the contact breaker and remedy the fault.
Faulty condenser - fit new one.
Water on contact breaker - blow out and wipe dry.
Damaged high tension coil. Fit new coil.
Damaged cable connector. Fit new connector.
Broken or loose cables from magneto-generator ignition coils to contact breaker and to spark plug.
Short circuit of wiring to earth. Check all cables and repair damage or renew.
Faulty ignition winding in generator yoke. Re-wind.
If no spark is produced at the end of the high tension lead or on the high tension terminal of the coil and a general check fails to reveal the source of ignition trouble, trace the source with an electric bulb testrig with dry battery and if possible with a voltmeter for alternating current.

The bulb tester or fault tracer consists of a bulb in series with the dry battery. One lead should be permanently connected to earth (mass) on the machine. The other lead is used to check the various circuits. Disconnect cables from terminal 1 on coil.

Connect tester to the cable leading to the contact breaker and rotate the crankshaft. If the bulb lights up at regular intervals but fat sparks appear on the contact breaker points, the condenser is faulty. If the bulb remains continuously lit when the crankshaft is rotated, the cause may be faulty insulation of cable 1 or an internally shorted condenser. If it is now found that the bulb gives an intermittent light as the crankshaft is being rotated, renew the faulty condenser or remedy the surface short circuit on it if that is the cause. Otherwise look for a short circuit in cable 1 or the contact breaker. The cam follower of the rocker arm may be worn to a point preventing the breaker points from separating.

If the bulb tester fails to light up at all as the engine is rotated, the various connections may be out of order, cable 1 severed, the contact breaker points may be burnt or the rocker arm spring fatigued or broken. The precise location of the trouble can be determined by checking the contact breaker with the bulb lead.

If the section from cable 1 to the contact breaker is found to be in order, connect the bulb lead to the other disconnected cable 1 leading to the lighting switch. The bulb should light up only when the switch is in OFF position, otherwise there is a short to earth in the cable.

If the procedure described fails to reveal the source of trouble, the fault will probably be in the coil which should be renewed. Faults in the ignition winding of the stator can be diagnosed by measuring the voltage on the magneto-generator terminal 15. If the engine is rotated by means of the kick starter, the voltmeter needle should give a reading in relation to the speed of rotation.

2. Irregular firing.

- a) A good spark is produced.

Beside carburettor trouble or defective fuel supply this symptom may indicate intermittent short circuiting of the cable connecting the magneto with the contact breaker or the lighting switch (cables 15,1) or a severed high tension lead to the spark plug. Trace the fault and remedy by fitting new cable or by the use of insulating tape. Terminal grub screws should be properly tightened and secured with a dab of paint.

b) Irregular sparking.

Of the possible causes, the most frequent are: an oiled or unsuitable plug, which should be cleaned or replaced. Excessive plug gap, which should be reduced to 0,5 mm. Soiled or burnt contact breaker points. Clean the points with a rag soaked with petrol and file flush with a fine file. Incorrectly set contact breaker gap. Re-set to approx. 0,4 mm. Faulty condenser, the engine will not run above idling speed. Regular intense sparking at the contact breaker points.

Fit new condenser.

Intermittent short circuiting of cables as with regular spark.

3. The engine runs on after the ignition has been switched off.

Severed cable 1 from ignition winding to lighting switch.

Faulty connection of lighting switch to earth by means of terminal 31.

Oxidised contact points in the lighting switch.

Trace the fault, fit new cable, connect properly, clean contacts.

B. Faults in the lighting system.

1. Unduly short bulb life, repeated burning-out.

This trouble may arise on the earlier model without the choke coil.

a) Faulty dipswitch contact points. When dipping, the main beam is switched off and the dipped beam does not light up immediately (or vice versa). The brief period during which neither of the headlamp filaments consume current results in temporary overloading of the tail bulb which takes the whole generator output.

The remedy is to fit the choke coil (see wiring diagram 2) or to modify the installation as shown in wiring diagram 3.

b) Loose cable to bulb in retaining terminal, or the bulb does not make proper contact with its socket. Oxidised connections. Make frequent checks of cable fasteners and tighten terminal screws. Secure terminal screws with a dab of paint. Clean cable connections, bulb sockets and bases.

A permanent remedy for unduly short bulb life owing to these causes will be effected by modification as shown in wiring diagram 2, partial improvement can be brought about by adopting the layout shown in wiring diagram 3.

c) Too powerful permanent magnets — the bulbs burn out at high engine speeds. Measure the voltage at about 4000 r. p. m. with a full loading of 15+5 wats. If tension is excessive, demagnetize permanent magnets.

d) Too low bulb rating.

Fit the recommended 15/15 W/6 V bulbs.

2. Lights will not light up with engine running and switch in ON position.

Possible causes:

a) Burnt out bulbs — fit new bulbs.

b) Loose leads in terminals (55, 56, 58) or broken cables. Secure cables, inspect soldered connections to switches, repair or replace cables.

c) Faulty dipswitch or lighting switch. Locate the short circuit and repair, or fit new cable.

d) Short circuit of cables 55, 56, 58 to earth. Locate the short circuit and repair, or fit new cable.

Trace the faulty cable by gradual elimination, disconnecting one cable after another. First turn switch to "daylight riding" position, start the engine and press the buzzer button. If the buzzer produces a sound of adequate volume, the location of the short circuit will be between the lighting switch terminal

56 and the bulb. Switch over to "night riding" and remove one bulb lead after another from the lighting switch. The buzzer will sound as soon as the defective cable is disconnected.

e) Faulty magneto-generator, short circuit or severed windings. Rewind or fit new coils.

3. Weak light produced even at peak engine speed.

a) Too powerful bulbs fitted. Fit 15/15 W/6 V and 5 W/6 V bulbs.

b) Partial short circuit to earth by some cable. Trace as under 2 — d.

c) Faulty lead connection to terminal, oxidized terminal. Secure lead properly, clean terminal surface.

d) Short circuit in one of the lighting coils of the generator. Rewind the generator coils.

e) Partial loss of magnetism of permanent magnets. Remagnetize.

C. Failures of the audible warning device.

1. Horn or buzzer will not sound.

With a hooter, this trouble is usually caused by faulty dry battery connections. Other sources may be the battery holder terminals or a horn button with oxidized contact points. Severed or shorted cables may also be the cause. If a short circuit occurs in the cable from the battery to the horn, the battery will be ruined.

In the case of machines fitted with an AC buzzer, possible causes are: severed or shorted cables from lighting switch terminal 55 to the dipswitch horn button, faulty contact of cables with buzzer terminals or horn button terminals, or faulty button contact points.

The buzzer will not produce the usual tone when the lights are on when engine revolutions are low. This is normal and no trouble is indicated.

2. Horn produces weak note.

Fit a new dry battery.

3. Horn or buzzer off sound.

Adjust the horn or buzzer tone by the adjustment screws.

4. Spontaneous sounding of horn or hooter with the machine running.

Spontaneous sounding will occur if the contact screw inside the dipswitch unit makes contact with the unit cover or if the cable from the horn or buzzer is shorted to earth. Renew cable insulation or replace cable. If the trouble is caused by the screw or cable making contact with the cover, insulate both by fitting a 4 mm dia. plastic tube of 15 mm length over the cable end and screw. The tube should have one end cut off obliquely and the pointed flap thus produced should cover the screw head.



Special tools for the 50 c. c. Jawa, model 555 and the Manet scooter.

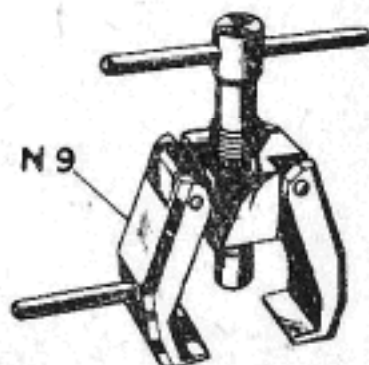
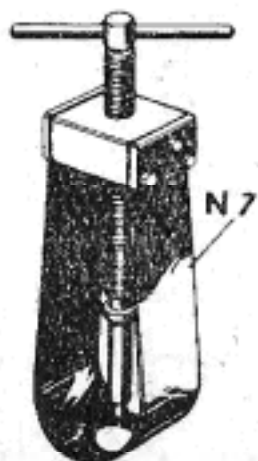
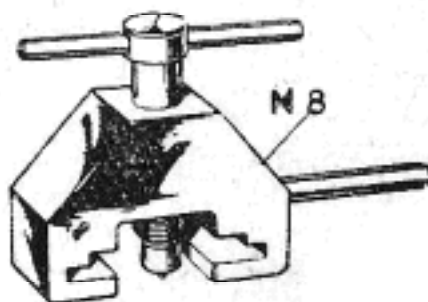
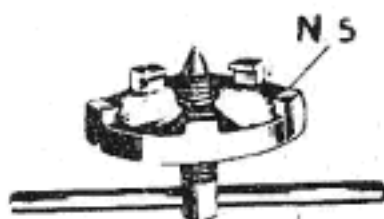
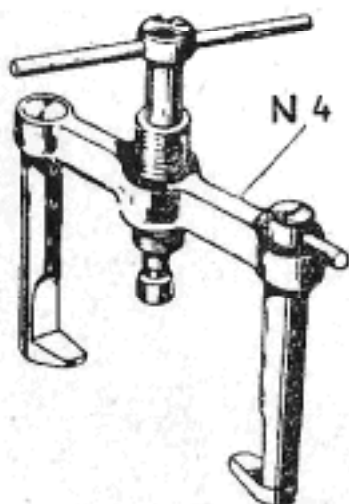
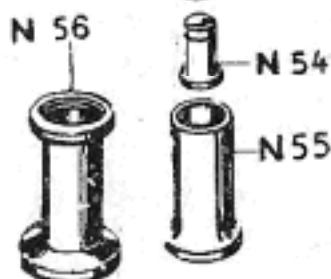
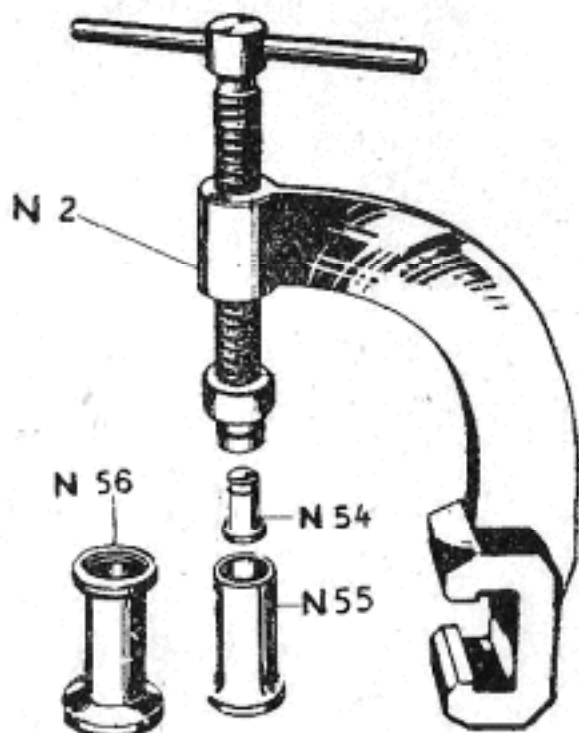
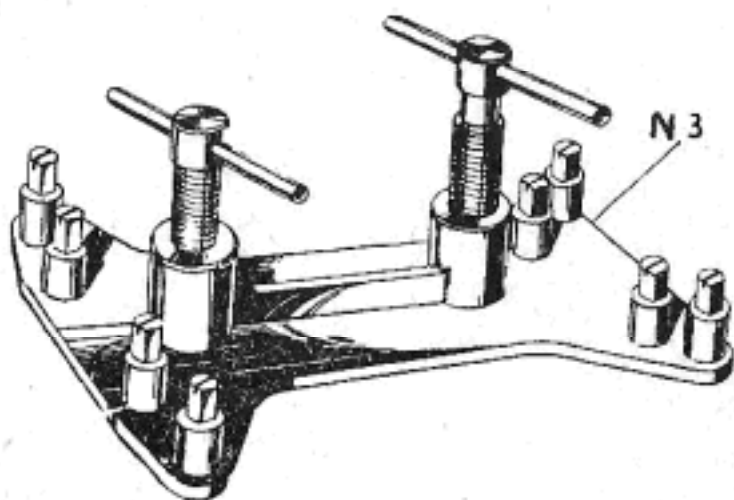
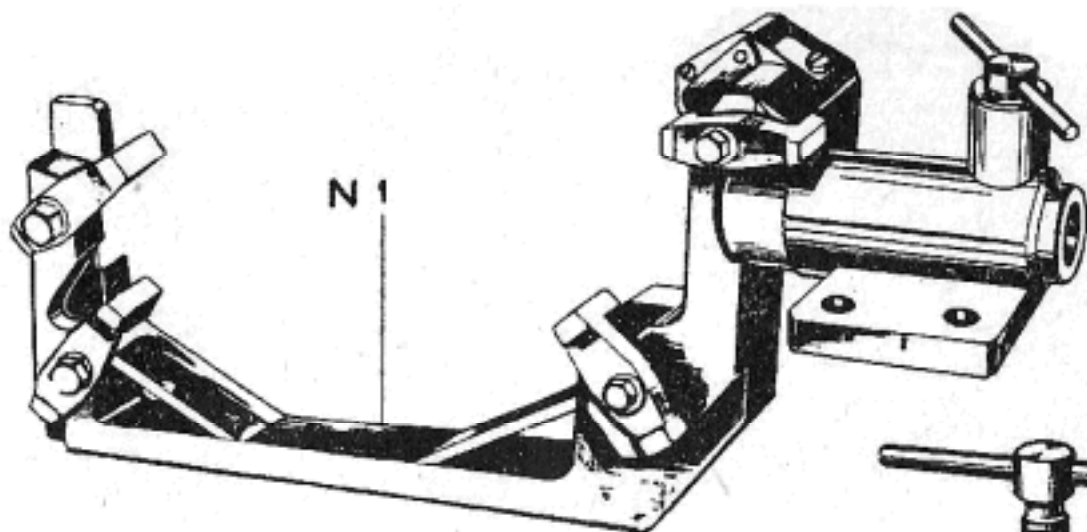

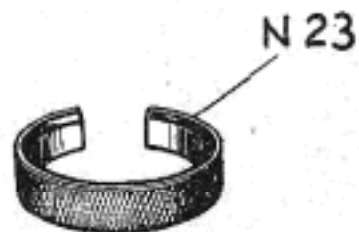
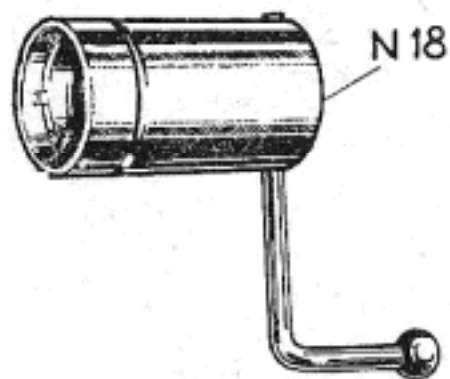
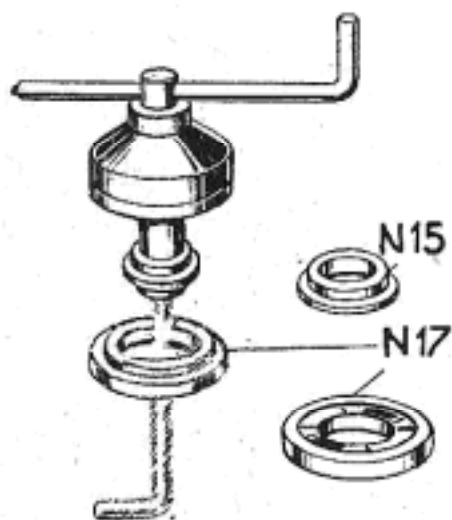
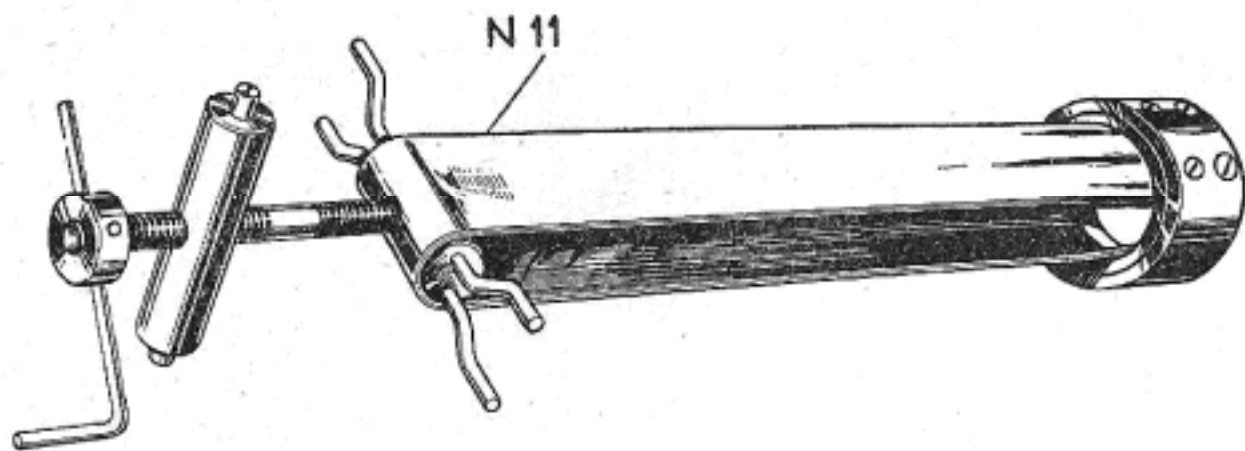
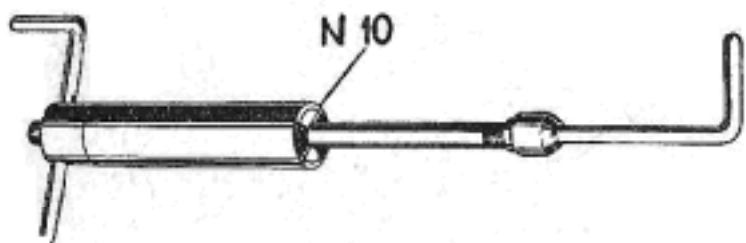

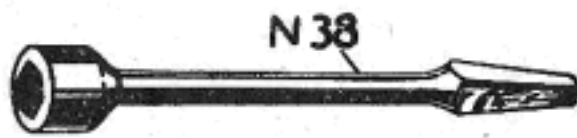
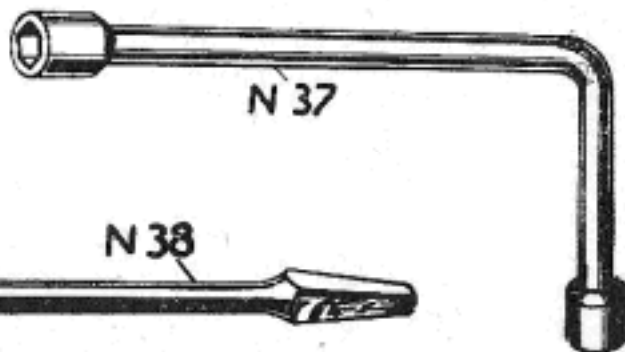
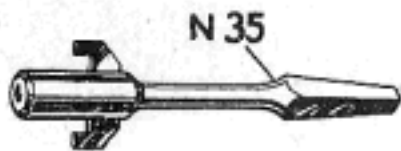
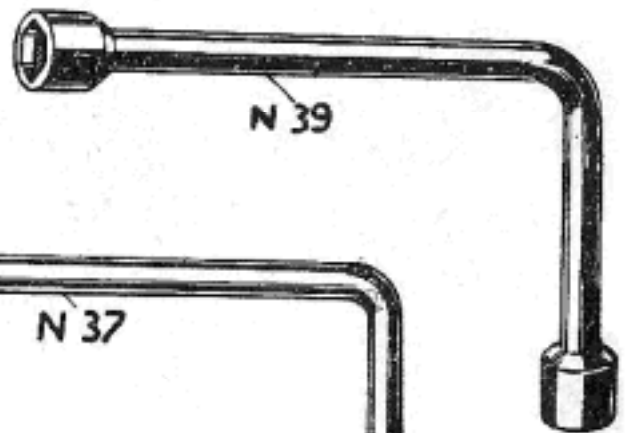
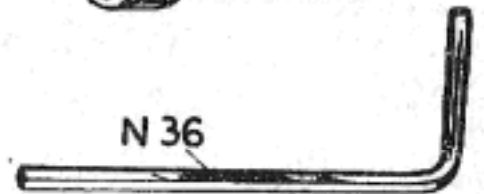
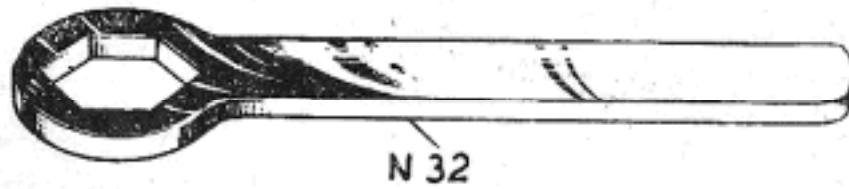
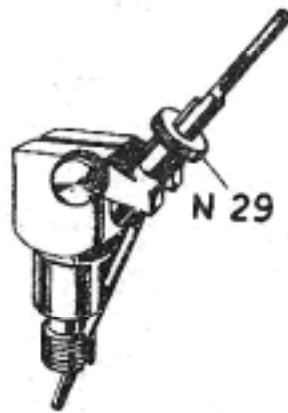
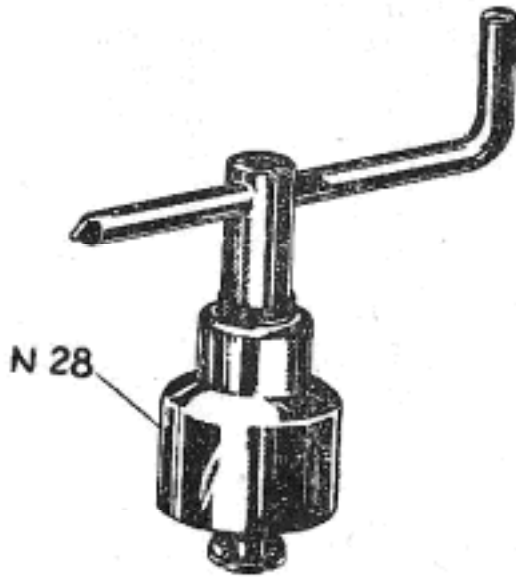
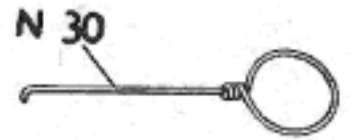
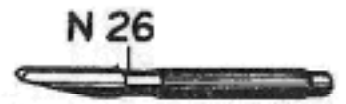
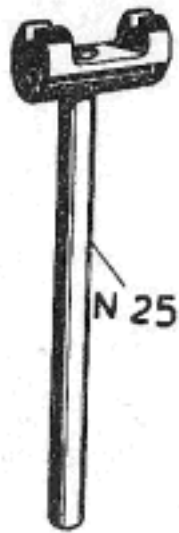
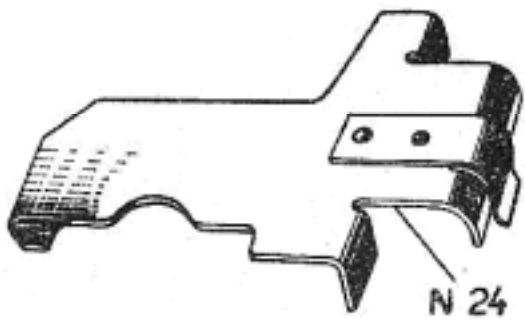



N 40



N 41



N 43

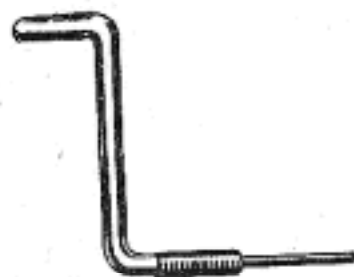

N 44



N 42



N 45

N 46



N 47

N 48

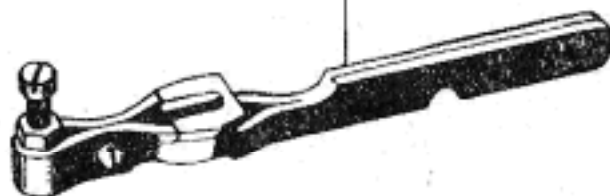

N 57

N 58

N 49



N 50

N 51

N 52

N 53

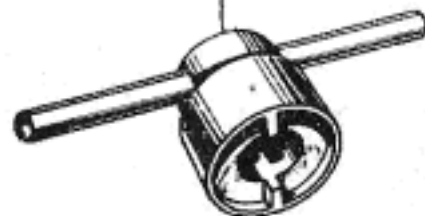

SERVICE TOOLS

FOR THE LIGHTWEIGHT MOPED JAWA 50 c. c. MODELS 550 AND 555 AND FOR THE SCOOTER MANET S 100
1st EDITION 1959

POVAŽSKÉ STROJÁRNE N. C. POVAŽSKÁ BYSTRICA

Item	Tool	Application of tool
N 1	Engine assembly stand	Used for fixing engine for disassembly and assembly purposes
N 2	Extracting and pressing tool	Together with application of N 1 used for pressing out the crankshaft mechanism as well as of the bearings and Guffero sealing rings. Supplemented with tools N 54, N 55 and N 56
N 54	Extracting insert I.	
N 55	Extracting insert II.	
N 56	Extracting insert III.	
N 3	Crankcase dividing tool	For dividing the crankcase halves
N 4	Clutch depressing tool	Used for depressing the clutch during its assembly or disassembly
N 5	Clutch drum puller	For disassembling the clutch driving drum
N 6	Rotor pulling device	For disassembling of dynostarter rotor
N 7	Gudgeon pin extractor	For pressing out of gudgeon pins
N 8	Fixed puller of sprocket	For pulling off the secondary sprocket wheel
N 9	Adjustable sprocket puller	For pulling all the other sprockets and chainwheels and for pulling off the clutch on J 50 machines
N 10	Pivoted fork pin extracting tool	For pulling the rear pivoted fork pin
N 11	Front telescopic fork spring depressing tool	For disassembly of the front fork telescopic spring
N 12	Guffero I sealing ring extractor	For disassembly of the rubber seal located on the R. H. side of the crankshaft mechanism dia 17×35×10 S 100 and dia 15×35×7 on the J 50
N 13	Guffero II sealing ring extractor	For disassembly of the rubber sealing ring dia 28×47×10 located on the L. H. side of the crankshaft mechanism
N 14	Guffero III sealing ring extractor	For disassembly of the rubber seal dia. 30×40×7 located on the R. H. side of the secondary sprocket
N 15	Extractor washer	Together with tool N 17 serves for pulling off chainwheel bearings
N 16	Crankshaft mechanism bearing puller	For pulling off the crankshaft mechanism bearing together with tool N 17
N 17	Bearing puller	Used with tool N 15 or N 16
N 18	Wrench for top cone of head fittings	For assembly and disassembly of the steering head fittings top cone
N 19	Bush drift	For knocking off joining securing bushes of the crankcase
N 20	Fixing plate	For securing the clutch against turning when it is disassembled or assembled
N 21	Fixing insert	Secures the primary chainwheel against turning as well as the clutch wheel during unassembly
N 22	Ring assembly tool	Used for assembling piston rings to pistons
N 23	Piston rings socket	For fixing piston rings during mounting of cylinder barrel over piston
N 24	Trace gauge	For adjusting the rear wheel trace

Item	Tool	Application of tool
N 25	Spanner for spokes	For tightening the wheel spokes and for assembling the gear engaging shaft spring
N 26	Straightening tool for securing washers	On disassembly this tool is used for straightening the washers under the nuts of the primary and secondary transmission chainwheels and of the clutch driven drum. On assembly it is used for bending the washer
N 27	Guffero sealing ring protecting cap	To be put on the L. H. side crankshaft mechanism to protect the guffero sealing ring
N 28	Bearing extractor	For extracting the crankshaft mechanism bearings
N 29	Ignition advance gauge	Ignition advance is adjusted with this gauge to 4 mm
N 30	Slipping in hook	For slipping in the gear engaging mechanism claw spring
N 31	Pliers for piston rings	For disassembly of piston rings and for assembly and disassembly of circlips securing the S 100 clutch
N 32	Spanner 41	For tightening and slackening the steering head shaft
N 33	Tool for knocking on the driven drum of clutch and primary sprocket	On assembly of the driven drum of the S 100 clutch and on assembly of the primary chainwheels of the S 100 and J 50
N 34	Centering needle	For centering the slots on assemblies of engines into frames
N 35	Screwing in tool of the rear pivoted fork	For assembly and disassembly of the rear pivoted fork nut
N 36	Rotor spanner 6 for tightening rotor screw	For assembly and disassembly of electric motor rotor
N 37	Box spanner 9×10	For disassembly and assembly of screws and nuts of the due sizes
N 38	Box spanner 12 into wrench	
N 39	Box spanner 14×17	
N 40	Box spanner 19	
N 41	Spanner 11 to 12	For holding nuts on assembly of engine
N 42	Spanner 27 and securing of clutch	Together with N 52 used for securing clutch on disassembling (J 50). This spanner is applicable for: J 50 for slackening secondary sprocket, S 100 for slackening chainwheel hub nut
N 43	Rubber bushes knocking off tool	For extracting rear pivoted fork reaction bush
N 44	Rotor puller	For disassembly of generator rotor
N 45	Extractor of pivoted fork lids	For disassembly of pivoted fork covering lids
N 46	Depressing lever of clutch springs	For assembly and disassembly of clutch-depressing clutch springs and fixing the circlips. Simultaneously the tools N 57 and N 58 are used
N 47	Bush extracting tool	For knocking off securing connecting bushes of crankcase
N 48	Wheel spoke spanner	For tightening the wheel spokes
N 49	Piston ring assembly tool	Used for assembly of piston rings
N 50	Piston rings socket	For fixing piston rings when cylinder barrel is assembled
N 51	Fixing insert	For fixing the primary sprocket and clutch against turning during disassembly
N 52	Securing member	Used together with tool N 42 for disassembly of clutch
N 53	Wrench tool for telescope screws	Used for assembly and disassembly of the telescope
N 57	Fork insert	Used simultaneously with N 46 for assembly and disassembly of circlips and washers of clutch springs
N 58	Disassembly insert	