

SPECIFICATION AND OPERATOR'S MANUAL

JAWA 50 Model 05

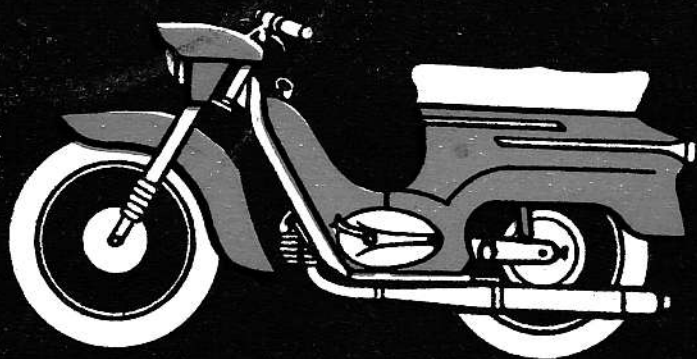

**POVAŽSKÉ STROJÁRNE N. P.,
POVAŽSKÁ BYSTRICA**

LIGHTWEIGHT SCOOTER

JAWA 50 Model 05



SPECIFICATION AND OPERATOR'S Manual

Cylinder capacity	49,9 c. c.
Maximum power output	3 HP at 6,000 r. p. m.
Manufacturers	Považské strojárne N. C. Považská Bystrica
Exporters	MOTOKOV PRAHA ČSSR

1965

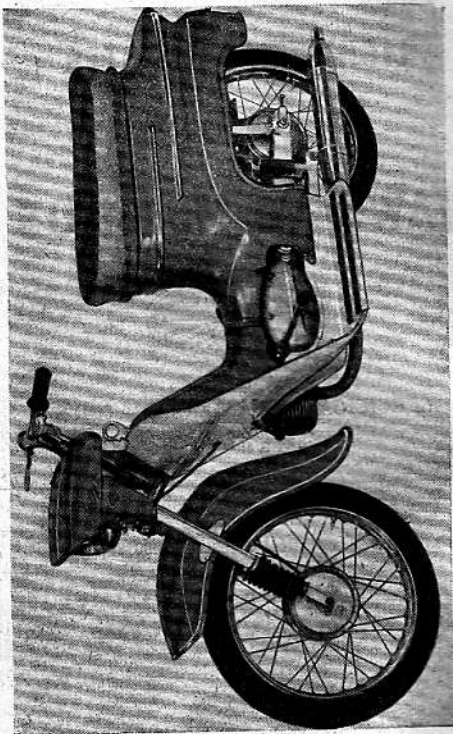

1. JAWA 50 ,model 05, Lightweight Scooter.

The JAWA 50, model 05 Lightweight scooter you have just acquired is the result of many years of development of the wellknown JAWA 50 — model 550 and 555 motorcycle.

The experience gained with the previous models has been applied to the design of the scooter and many new features introduced.

Modern design, higher engine power, improved suspension and perfect weather protection provide reliable and comfortable riding as well as easy handling.

This Manual will help you to become acquainted with your mount and to acquire the necessary knowledge of its components and their operation. It will advise you on maintenance and how to remedy minor defects. In your own interest rely on the Manual for information; you will thus avoid possible damage to your machine.

Accept our best wishes for many thousands of pleasant and joyfull miles with your new scooter!

Považské strojárne,
National Corporation,
Považská Bystrica

IMPORTANT:

This Specification and Operator's Manual do not finalise the design and equipment of the JAWA 50 scooter. The right to alter the design as a result of further development of the machine regardless of the illustrations and description in the Manual is reserved.

INDEX

I. Technical data and riding instructions	7
1. Technical data	7
2. Running in a new machine	8
3. Riding instructions	18
4. List of tools	18
II. Maintenance	18
1. Cleaning the scooter	18
2. Lubricating the scooter	19
3. Adjusting the brakes	25
4. Tyres	26
5. Adjusting the chain	28
6. The clutch and its adjusting	29
7. The „JIKOV“ 2915 PS caburette	31
8. Electrical equipment maintenance	33
9. Decarbonisation	35
10. Scooter maintenance table	37
III. Dismatling and assembling without special tools	40
1. Removing the front wheel	40
2. Removing the rear wheel	40
3. Replacing the wheel ball bearings	43
4. Replacing the chainwheel ball bearing	43
5. Tipping up the seat	44
6. Dismatling and assembling the cowls	45
7. Removing and replacing the cylinder barrel	46
8. Replacing the piston rings	47
9. Dismatling the headlamp	48
10. Dismatling the front fork	50
11. Pivoted rear fork	51
12. Replacing the speedometer flexible shaft	51

13. Replacing the throttle cable	53
14. Replacing the clutch cable	54
15. Replacing the brake cable	55
16. Removing the engine from frame	55
IV. Jawa 50, model 05 Sports	56
V. Defects, causes and remedies	58

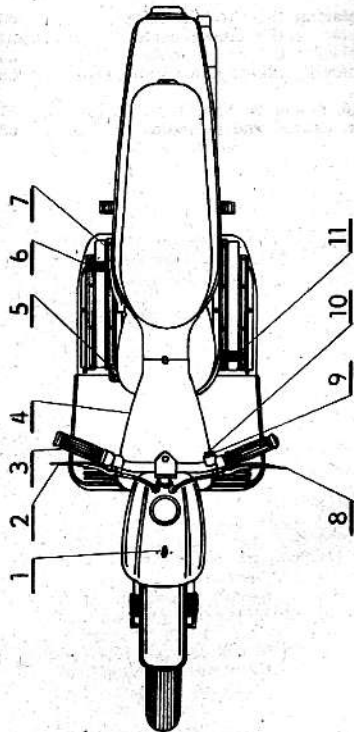

2. Steering and controls: 1. Switch box — 2. Front brake lever — 3. Throttle twist grip — 4. Carburettor — 5. Rear brake pedal — 6. Kickstarter pedal — 7. Fuel tap — 8. Clutch lever — 9. Buzzer push button — 10. Dip switch — 11. Gear change pedal.

I. TECHNICAL DATA AND RIDING INSTRUCTIONS

1. TECHNICAL DATA

- Engine — two-stroke, air-cooled
 Number of cylinders — single
 Bore — 38 mm
 Stroke — 44 mm
 Cylinder capacity — 49,9 c. c.
 Compression ratio — 7,5 to 1
 Maximum power output — 3 HP at 6,00 r.p.m.
 Fuel tank capacity — 1,2 galls. (5,5 litres)
 Weight — dry — 143 lbs. \pm 2% (65, kg \pm 2%)
 Payload — 352 lbs. (160 kg)
 Primary drive — by CZ-Favorit chain $3/8 \times 3/8$ in., 44 links
 Final drive — by chain $12,7 \times 5,2$; 109 + 1 links
 Overall gear ratios
 Bottom gear 28,99 to 1
 Second gear 15,21 to 1
 Top gear 10,28 to 1
 Carburettor — Jikov 2915 PS
 Wheels — front and rear interchangeable
 rims — 1,50 A \times 16 in.
 tyres — 2,75 \times 16 in.
 Internal expanding brakes — dia 125/20 mm
 Front wheel suspension — telescopic fork, suspension travel 90 mm
 Rear wheel suspension — pivoted rear fork with dampers, suspension travel 85 mm
 Magneto — 6 V with windings for feeding the ignition coil, the headlamp bulb 15/15 W and the identity end plate bulb 5 W
 Ignition coil — 6 V, 02-9211.04
 Sparking plug — PAL 14-7 RZ with suppressor

Average fuel consumption — 0,5 galls./60 miles
 — 2,5 l/100 km
 Maximum speed — 37 m.p.h. (60 km p.h.)
 Maximum climbing ability — 25 %

2. RUNNING IN A NEW MACHINE

When taking over a new machine it is recommended to check its equipment (tools) as well as the oil level in the gearbox. The oil level is determined by the inspection hole closed with the M 6 x 8 oil level screw (Fig. 9).

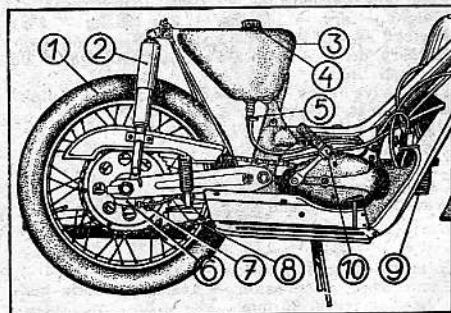

3. JAWA 50, model 05, Lightweight Scooter — view of the rear part of the machine. 1. Rear wheel — 2. Telescopic oil damper — 3. Fuel tank — 4. Fuel tank filler cap. — 5. Fuel tap — 6. Speedometer drive — 7. Speedometer flexible shaft — 8. Rear chain — 9. Engine — 10. Kickstarter pedal.

Proper running in of the new machine has an important bearing on its output, consumption and durability.

When running in a new machine adhere to the following instructions:

- a) Mix the fuel to the prescribed ratio of oil and petrol following the Lubrication chart.
- b) When running in up to 900 miles do not

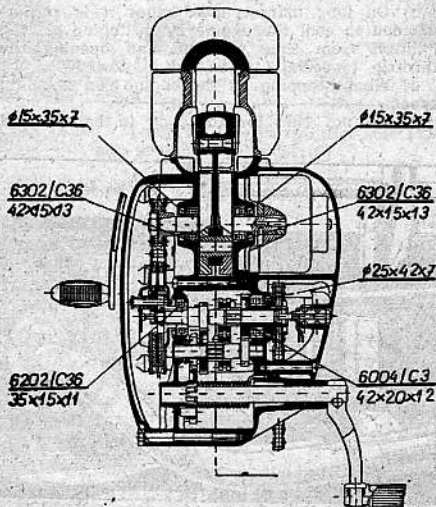

4. Engine — Sectional view

exceed the following maximum speeds in individual gears:

Bottom gear	10 m. p. h. (17 km p. h.)
Second gear	20 m. p. h. (33 km p. h.)
Top gear	30 m. p. h. (48 km p. h.)

Do not ride in bottom gear for too long. For the first 400 miles 1 person may drive the machine only.

c) On long uninterrupted rides it is recommended to cool the engine by switching off the ignition from time to time and opening the throttle (especially when riding downhill).

d) When stopping let the engine run at idling speed.

e) Do not ride for too long in bottom and

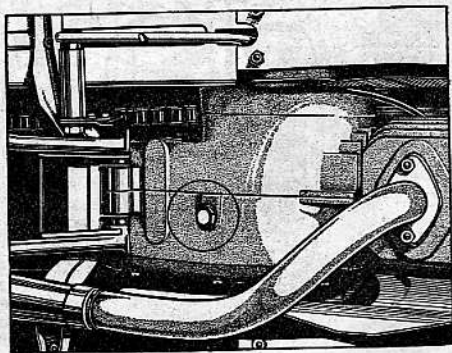

5. Oil draining screw

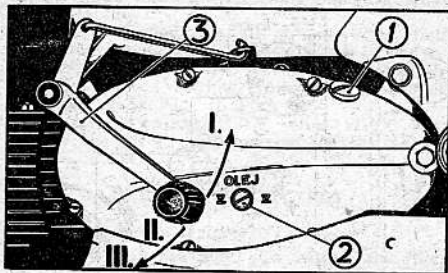

6. Oil filling (1) and oil level inspection hole (2) and gear change pedal (3)

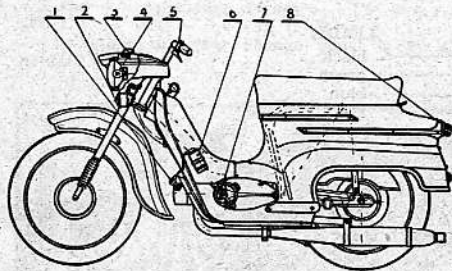

7. Electric current sources and accessories 1. Sparking plug — 2. Buzzer — 3. Switch box — 4. Headlamp — 5. Dip switch and buzzer push button — 6. Ignition coil — 7. Magneto (on the R. H. side) — 8. Tail lamp.

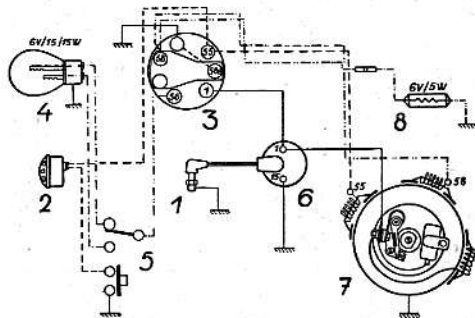

LEADS:

— black
 - - - green
 . . . blue
 - - - red

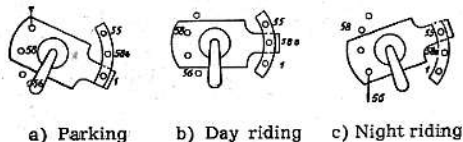

8. Electric wiring diagram and switch box lever positions.

second gear. When riding uphill engage a lower gear in time.

f) Check periodically all screws, bolts, nuts and spoke nipples.

g) Having covered 300 miles (500 km) drain the oil from the gearbox. Rinse with rinsing oil and refill (see Part II, Para 2).

h) Having covered 1,800 miles (3,000 km) change the oil in the gearbox for the second time.

3. RIDING INSTRUCTIONS

A. Check before a ride:

1. the fuel in the tank. (To remove the filler cap rotate it anticlockwise.) Mix oil with fuel according to the Lubrication Chart. To fill the tank use a funnel with strainer.

2. the brakes, lights and buzzer;

3. the tyre pressure (front — 1,5 atm. g. (21 p. s. i.), rear — 1,9 atm. g. (27 p. s. i.)).

4. whether the gear change pedal is in its neutral position.

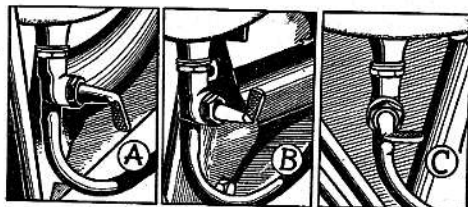

a) On b) Reserve c) Off

9. Fuel tap lever positions

B. Starting the engine

1. Open the fuel tank tap through the opening in the rear cowl R. H. side (Fig. 11).
2. Flood the carburetter by pressing the tickler pin through the opening in the R. H. side of the front cowl (Fig. 22).
3. Switch the switch box lever in the headlamp nacelle to the central position (Fig. 8).
4. Kick the starter pedal down (in the direction of travel) to start the engine.

If the clutch lever of the JAWA 50 scooter is depressed before starting, the clutch will slip. Therefore, do not declutch when starting the engine. If the clutch lever has been depressed by accident, push-start the machine.

C. Riding

Starting from standstill: To engage bottom gear depress the clutch lever. With the tip of your left foot push lightly the gear change pedal right up, moving the machine slightly at the same time, until bottom gear is engaged (Fig. 9). Opening the throttle release the clutch lever slowly and gradually (especially in the second half of its travel when the machine starts moving off) to start off smoothly. Having reached the speed of 9—12 m. p. h. (15—21 km p. h.) depress the clutch lever while closing the throttle. With the tip of your left foot depress fully the gear change pedal and release it. Second gear is thus engaged. Release quickly the clutch lever and open the throttle.

Having reached the speed of 17—25 m. p. h.

(28—40 km p. h.) engage top gear in a similar way.

Do not use force when operating the gear change pedal, as you might damage the gear change mechanism and bend the gear change lever.

Permissible speeds in individual gears:

Bottom gear 0 to 13 m. p. h. (0 to 21 km p. h.)

Second gear 9 to 25 m. p. h. (15—40 km p. h.)

Top gear up from 17 m. p. h. (28 km p. h.)

Most economical and suitable speeds in individual gears:

Bottom gear 6 to 12 m. p. h. (10—19 km p. h.)

Second gear 12 to 21 m. p. h. (20—34 km p. h.)

Top gear 10 to 31 m. p. h. (31—50 km p. h.)

Riding uphill. As soon as the engine revolutions begin to drop when riding uphill change to lower gear. To change from top to second gear change lever up. Changing down has to be done more quickly than changing up, the climbing machine would otherwise lose speed while the clutch is depressed.

Engage bottom gear in the same way.

Important: when a higher gear is engaged, the engine operates in lower revolutions than before. Do not try to prevent this by depressing the clutch lever and letting the clutch slip. When the clutch is slipping the excessive friction overheats the clutch plates and the plates may burn.

Braking: When riding downhill or stopping (slowing down) use the brakes. Closing the throttle depress first the rear wheel brake lever and only then use the front wheel hand brake. If possible, use the brakes with caution and gradually, sudden braking makes the wheels skid.

Special care is recommended when braking on slippery ground and when coming from a hard surface to a dusty road.

Stopping: When stopping close the throttle, depress the clutch lever, brake and shift into neutral between the bottom and second gear. This is done by pressing (pushing) the gear change lever down (up) half the way necessary to engage a gear. To stop the engine turn the switch box lever to the left (Fig. 8). Do not forget to turn off the fuel tap (Fig. 11). Having finished riding for the day let the engine run at low revolutions with the fuel tap closed till all the fuel in the carburetter is consumed. With the engine at a standstill, the oil in the mixture in the carburetter might choke the jet.

Night riding: When riding during the night (or in fog) switch on the headlamp and tail light by turning the switch box lever to the right (Fig. 8). Main and dipped beam is controlled by the dip switch on the L. H. handlebar.

D. How to prevent defects

If the instructions for running in and further maintenance are not followed defects may occur. The most frequent consequence of incorrect running in is sticking of the piston rings in their grooves, the result of which is a lowered engine output, or even a seized piston.

Incorrect running in often does not manifest itself in a visible defect, but in premature wear of different parts and a considerable increase in fuel consumption.

Seizing of the piston is mostly caused, by engine overheating, which is usually accompanied by a characteristic slight pinking. As soon as you hear this sound switch the ignition off,

so that the fresh unignited mixture can cool off the engine.

If the engine starts losing power it is also due to seizing; it is necessary to declutch and stop. If the piston has seized, let the engine cool off and then try to restart it. On your return check the piston, piston rings and the cylinder inside. Should a repair be necessary, entrust it to a specialised workshop.

It is harmful to let the engine run while it is standing as it is not being cooled. Do not keep it declutched for any considerable time as the cork inserts of the clutch plates would be subject to unnecessary wear. Never help the engine uphill by letting the clutch „slip“ but engage a lower gear in time. Do not ride in lower gears for too long.

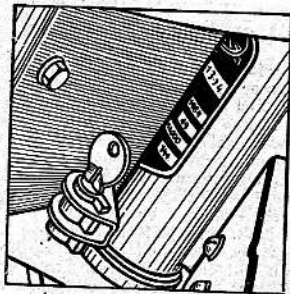

10. Locking the vehicle

4. LIST OF TOOLS NECESSARY FOR MAINTENANCE OF THE JAWA 50, MODEL 05, SCOOTERETTE

1. Tool kit
2. Box spanner 14/17
3. Open double ended spanner 9/10
4. Box spanner 10
5. Handle dia 5
6. Combined spanner 32/27
7. Contact breaker point gap feeler gauge
8. Screwdriver 3 mm
9. Tyre levers
10. Tyre inflator
11. Rubber tube
12. Sparking plug spanner
13. Double ended screwdriver
14. Lock

The tyre inflator is located under the dual seat. The remaining tools are fastened to the frame with rubber bands under the front cowl.

II. MAINTENANCE

1. CLEANING THE SCOOTER

The simple smooth lines make the cleaning of the scooter easy. Use water for washing, preferably with a sponge. Wash with paraffin the parts that have been soiled with oil and dust. When washing take care to keep the carburetter, headlamp and brakes clear of water.

Wipe dry chromium plated and enamelled parts and polish them with flannel or chamois leather. The enamelled parts should be polished now and then with an enamel polish. To remove the water from the cylinder cooling fins, start the engine; its warmth will cause the water to evaporate.

Note. Petrol, paraffin and oil dissolve rubber (tyres, handlebar grips, footrest sleeves, rubber blocks of the pivoted rear fork and footboard

rubber). Therefore protect the rubber parts from contact with the liquids mentioned.

2. LUBRICATING THE SCOOTER

To lubricate the scooter see the Lubrication Chart. The engine is lubricated automatically by adding oil to the fuel at the ratio stated in the Lubrication Chart.

The gearbox: top up the oil every 600 miles (1000 km) up to the inspection hole in the L. H. cover. Change the oil having covered the mileage stated in the Lubrication Chart after a ride while both the engine and oil are warm. Drain the old oil through the draining hole in the crankcase bottom. Through the filling hole (Fig. 9) pour into the gearbox approx. 400 c. c. (24 cub. in.) rinsing oil and let the engine run at low revolutions for about 10 minutes - (ride a short

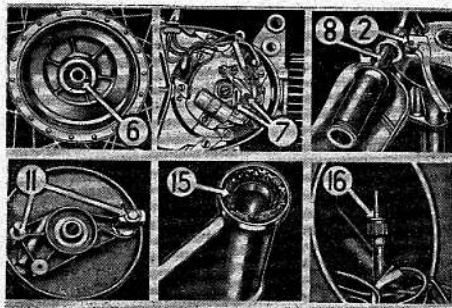

11. Lubricating the scooter

distance). Change to all gears. Then drain the rinsing oil into a clean vessel, let the impurities settle down and pour off the clean oil for use next time. Replace the draining screw and refill with fresh oil up to the inspection hole in the L. H. cover (approx. 500 c. c. — 34,9 cub. in.). Do not forget to replace the washers correctly.

The clutch runs in an oil bath (oil from the gearbox).

Telescopic front fork: lubricate after every 600 miles (1000 km); put the oil diluted grease into the fork legs by means of grease nipple after screwing off two screws M 6x7 at the back part of telescopic fork (behind the headlamp). Having covered 3.100 miles (5.000 km) dismantle the fork and lubricate carefully with grease.

Wheels (bearings) have to be lubricated every 1.500 miles (2.500 km). Dismantle the wheels (see Part III, Para 3—4), wash the bearings in benzine, dry and fill them with grease. Fill up with grease the space of sealing rings at the shaft approximately to one third to avoid the penetrating of impurities and moisture. Do not overfill the wheel hubs!

The pivoted rear fork telescopic oil dampers (Fig. 33) are highly efficient and are so arranged that there is no need to top up the damper liquid. Top up the damper liquid only if the pivoted rear fork is oscillating freely or bottoming or if the liquid is leaking. Otherwise change the oil once in two years. Entrust the topping up or the change of liquid to a specialised workshop.

The primary chain is completely enclosed by the L. H. crankcase cover, runs in an oil bath and does not require any maintenance. If worn or stretched too much it has to be replaced. If the primary chain has to be replaced, it is necessary to dismantle also the clutch. It is

recommended to entrust this repair to a specialised workshop equipped with the necessary tools.

The secondary chain has to be serviced every 1.500 miles (2.500 km) as follows: Rotate the chain until the connecting link reaches the rear chainwheel, slacken the spring clip with a screw driver (Fig. 12), remove it, and the chain is disconnected. Wash it in paraffin and remove the coarse impurities with a wire brush. Then rinse again thoroughly in paraffin. Let it dry and then place it for about 30 minutes into a slightly warm lubricant (approx. 60—70 °C) and move it from time to time to make the warm mixture penetrate the chain links better. Then take out the chain, let the lubricant solidify and remove the surplus grease from the surface. The chain is ready to be refitted. When assembling take care that the connecting link spring clip does rotate with its full end in the direction of the chain rotation.

Otherwise clean the secondary chain on the machine with wire brush and lubricate it, if

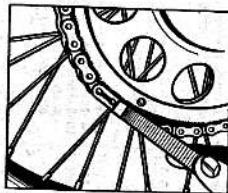

12. Removing the rear chain connecting link spring clip

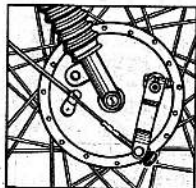

13. Adjusting the brakes

LUBRICATION CHART

Miles (km) covered	○	□	△
	In hot weather: Gearbox oil PP 7 Castrol SAE 50 Shell Spirax 90 E. F. In cold weather: Gearbox oil PP 7 Castrol SAE 20-30 Shell Spirax 90 E. F.	Grease A OO Castrollese CL Castrollese graphited Shell Retinax A	Grease AVZ Castrollese heavy
Lubrication point			
500-600 (800-1000)	2 Hand lever pins 5 Gearbox (topping up) 10 Rear chain (add grease)	3. Foot brake pedal pin 4. Telescopic front fork	
1,500-1,800 (2,400-2,900)	7 Contact breaker arm pin (oil drop) 14 Control cables	8 Twist grip 10 Rear chain (place in hot lubricant)	7 Contact breaker felt (saturate with grease and oil) 6 Wheel bearings
3,000-3,200 (4,800-5,200)	5 Gear box (oil change) 16 Speedometer flexible shaft (after detaching oil some drops)	11 Brake cams 12 Kickstarter pedal pin 13 Centre stand pin 15 Steering head (grease after dismantling and washing) 17 Speedometer drive gear	

	18 Rear suspension telescopic dampers - top up, if necessary, 50 c. c. of damper liquid per damper; damper oil (Shock Oil, Damper Oil, X 100 20 W). When dismantling grease the damper coil spring with grease (Castrollese CL, Shell, Retinax A). Charge oil once in two years.
	5 Gear-box - during running-in after the first 300 miles (500 km) and next 1,500 miles (2,500 km) change the oil
	Fuel mixture: During running in (up to 900 miles - 1500 km) petrol with oil at a ratio of 20 to 1 (petrol with Castrol SAE 40-50 or Shell at a ratio of 20 to 1). After running in period (having covered 900 miles - 1500 km) with Castrol SAE 40-50 or Shell at a ratio of 24 to 1.

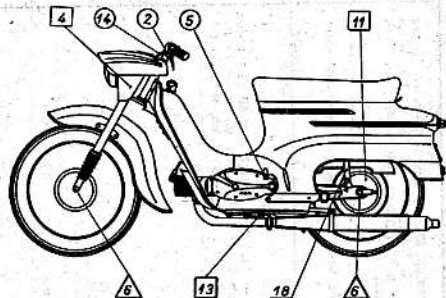

14. Lubrication Chart — L. H. side

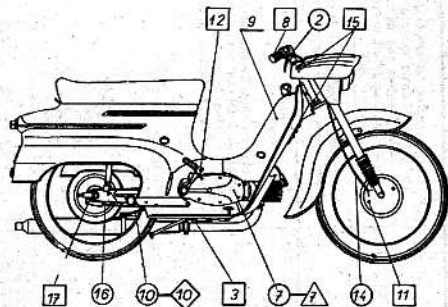

15. Lubrication Chart — R. H. side

necessary, after approx. 500—600 miles (800—1,000 km) by means of a paint brush. Running permanently in rain and on mud roads shorten the lubrication time properly.

Caution. The cylinder and crankshaft mechanism have to be sufficiently lubricated with oil. Lack of oil in the fuel causes seizure of the crankshaft mechanism. Therefore it is necessary to mix petrol and oil in the correct ratio. This ratio is not always correct when refuelling at automatic fuel stations after a vehicle with a fourstroke engine taking clean petrol. There may be too little oil in the mixture. It is therefore preferable to mix the oil and the petrol in a can to the correct ratio.

3. ADJUSTING THE BRAKES

The brakes of the machine are sufficiently dimensioned. They require only periodical adjustment due to wear of the brake shoe lining. To adjust the brakes, the brake cable has to be lengthened (shortened) by tightening (or loosening) the adjusting nut (see Fig. 13). Should it not be possible to adjust by tightening or loosening the nut it is necessary to reset the brake lever on the splined shaft and only then to adjust by means of the nut. After adjustment, check the wheels for easy rotation. The wheels have to rotate freely.

Setting the stop switch

The tail lamp bulb is operated by the stop light switch fastened on the R. H. footboard. After adjusting the rear wheel brake, check and set the stop switch so that the light is switched on at the same time as the foot brake begins to act. To set the switch, shift the complete switch

along the slot and tighten the fastening screws. The tail lamp bulb employed is 6 V 10 W.

4. TYRES

The life of the tyre depends on the inner tube air pressure in relation to the load carried. As a rule the tyre has to be inflated so as to keep its original shape even under full load. Running on under-inflated tyres will result in the cover wall cord threads breaking.

The pressure in the front tyre should be 1.5 atm. g. (21 p. s. i.), and in the rear tyre 1.9 atm. g. (27 p. s. i.) It is advisable to check the pressure with the tyre pressure gauge. Remember, that oil, petrol and hot sun is harmful for the tyres. Examine the tyres from time to time and remove all objects stuck in the pattern. To check



16. Rim and tyre — sectional view — tyre fitting

the tyre valve for leakage, unscrew the valve cap and moisten the tyre valve. Should any bubbles appear, the valve is leaky. In such a case tighten the valve core using the slotted valve cap for the purpose. If this is not sufficient, remove the valve core and replace it. A punctured tyre has to be patched. To remove the tyre from the rim, proceed as follows:

Unscrew the valve core — thus letting the remainder of air out. Unscrew the nut fastening the valve to the rim. Lay the wheel in a horizontal position and press the tyre edge well into the rim base at a point diametrically opposite to the valve (Fig. 18).

Using the tyre levers slip the cover edge over the rim edge (Fig. 17). Take care not to pinch the tube and thus damage it. Having slipped all the cover circumference over the rim edge press the valve completely out of the rim base and remove the tube.

Having screwed in the valve core and inflated the tube partially the punctured spot is best located by plunging the tube into water. Mark the punctured spot (e. g. with a copying pencil), dry the tube and repair it as follows:

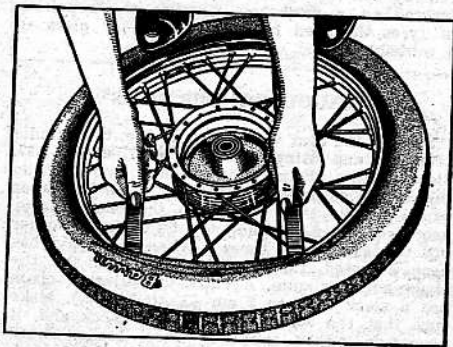

17. Tyre fitting

Rub the punctured spot slightly with a piece of sandpaper. Smear the rubbed spot with rubber solution. Allow the solution to dry and only the press on the patch first removing its protective coating. Press the patch well on to the tube. Examine the outer cover carefully and if the nail that caused the puncture is still in, remove it.

Fitting the tyre. Inflate the tube partially, insert it into the cover, one edge of which has remained in the rim, push the valve through the rim hole and secure it by its nut (do not tighten). Slip on the cover side over the rim edge beginning opposite the valve, work with hand or foot and tyre lever both sides towards the valve. Proceed carefully in order not to damage the tube. Tyre patching is an emergency remedy only. A permanent repair is best entrusted to a workshop. Entrust the repairing of tyres damaged by sharp gravel or glass to a workshop.

5. ADJUSTING THE CHAIN

Slacken the rear wheel spindle i. e. the spindle securing nut using spanners # 7 and # 27. Slacken the chain adjuster nut and tighten the chain adjusters uniformly, move the rear wheel spindle thus tensioning the chain. Never use force when handling the adjusters in order not to damage the thread. When the chain has been adjusted, tighten the wheel nuts and the chain adjuster nuts. A correctly adjusted chain has a slack of 1 to 2 cm (3/4 to 3/4 in.). Make sure that the wheels are in line. Check and, if necessary, adjust the rear wheel brake. Check the chain tension every 600 miles (1,000 km).

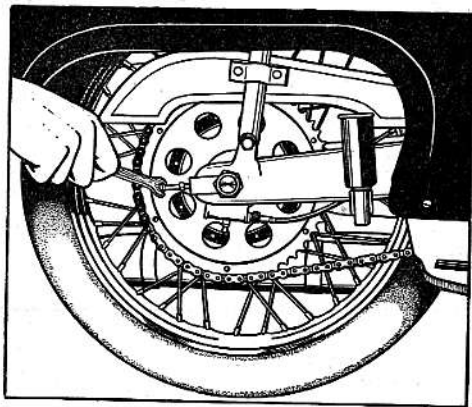

18. Adjusting the chain tension

6. THE CLUTCH AND ITS ADJUSTING

The clutch serves to interrupt the torque transmission from the engine to the gearbox. It is necessary to declutch before changing gear in order to protect gears from impact. The clutch runs in an oil bath and does not require other maintenance but the occasional adjustment of the control cable.

To prevent excessive wear of the plate when the clutch is slipping the plate has to be under sufficient pressure, and, therefore, the clutch lever has to have a small play. After a certain

normal wear of the clutch plate this play disappears. Sufficient play, therefore, has to be readjusted by slackening the adjusting bolt in the middle of R. H. crankcase cover (Fig. 20). Slacken the nut (1) and the bolt (2) and having adjusted the play tighten again.

If the clutch lever play becomes excessive due to the stretching of the control cable, adjust the play by slackening the securing nut of the adjusting bolt (3) in the bottom part of the R. H. crankcase half and rotating the adjusting bolt (4) by one or two turns. Having checked the clutch lever play, retighten the securing nut.

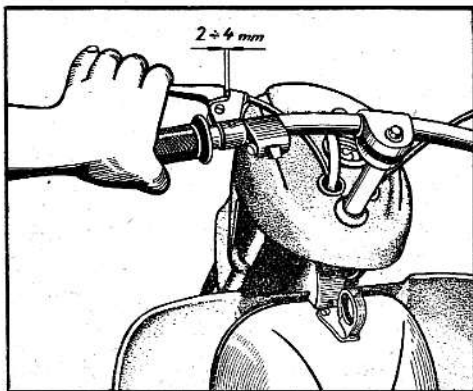

19. Clutch lever play

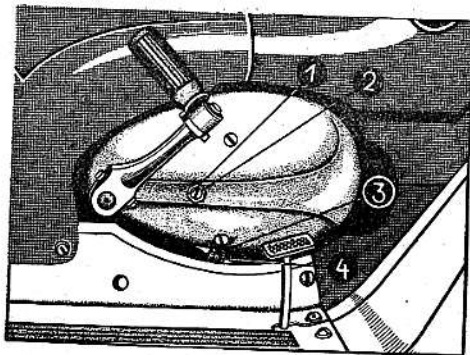

20. Adjusting the clutch

7. THE JIKOV 2915 PS CARBURETTER

The carburetter of the scooter has been set at the works. For its correct operation jet 60 has been employed. It is, therefore, not advisable to manipulate with the carburetter except for occasional cleaning. The carburetter has two jets in all, main jet 60 (1 — Fig. 22) and idling jet 38—40 (2). Between the two jets there is on the carburetter the pilot air screw with spring (3), by which the engine idling speed is set. To start the engine easily the pilot air screw (3) has to be in its correct position. Adjust the length of the throttle control cable with the grooved screw (4) in the carburetter top only when the idling speed has been correctly set.

When starting, flood the carburetter by tick-

ing the tickler pin in the float chamber lid (2 — Fig. 21). This makes the level in the float chamber rise thus creating a richer mixture and thereby more favourable conditions for starting the engine. The tickler pin is accessible through the opening in the front cowl R. H. half.

If one of the jets gets choked never use wire or any other hard tool to clean it, as this would damage the delicate jet hole, which, again would influence the consumption and operation of the engine. The jets are best cleaned by rinsing in petrol and blowing. The jets are to be reached after loosening the screw holding the tool box and after moving it round a slight amount. The needle of the throttle valve is adjusted for the breaking in period into the third groove from top, after the machine has been duly run-in, into the second groove from top.

The air cleaner is provided with microfilter ensuring the perfect filtration of sucked-in air. The cleaning of filter element is effected after

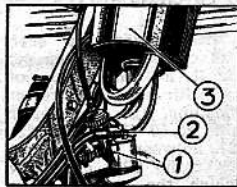

21. Carburettor with tickler and air cleaner — 1. Carburettor — 2. Tickler pin — 3. Air cleaner with induction silencer

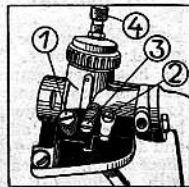

22. Carburettor JIKOV 2915 PS and its setting: 1. Main jet — 2. Idling jet — 3. Adjusting screw — 4. Cable guide.

every 300 km (1,800 miles) (in dusty atmosphere more frequently) by beating the impurities and blowing out with compressed air stream.

Micro-filter is neither washed nor oiled. The change of micro-filter takes place after driving 10 000 — 15 000 km. (6,000 — 9,000 miles).

8. ELECTRICAL EQUIPMENT MAINTENANCE

Leads: Check periodically and wind insulating tape round all insulation cracks. Damaged insulation can cause short circuits. Check all the lead terminals.

The sparking plug: Clean it periodically, carefully scrape off any carbon deposits and, if necessary, adjust the point gap to 0.5 mm (20 THOU) by carefully bending the outer point of the plug body.

The ignition coil is fastened to the frame. It does not require any maintenance. Check the lead from the ignition coil to the sparking plug: this has to be intact. Be careful with water when washing the machine!

The buzzer does not require any maintenance. The sound is regulated by tightening or slackening the regulating screw in the bottom buzzer housing.

The contact breaker. After every 1,500 miles (2,500 km) check the contact breaker lubricating felt, its contact with the cam and whether it is sufficiently oiled. The contact breaker and the whole magneto have to be kept absolutely clean. Be careful of fuel and oil!

Ignition advance: Remove the cylinder head. Rotate the crankshaft (1 — Fig. 23) till the piston reaches TDC (the piston is in its highest position). In this position set the contact breaker point gap (3) to approx. 0.4 mm (16 THOU) having slackened the screw (2). When the gap

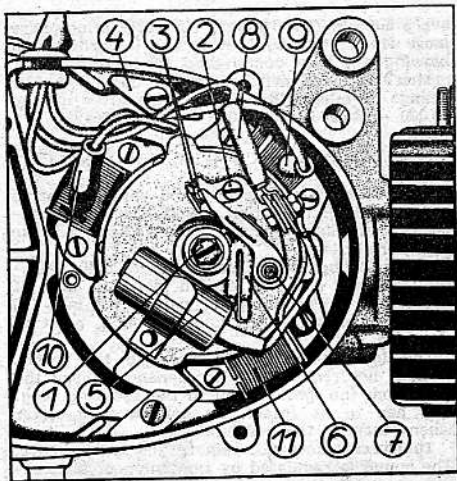

23. Magneto.

has been set, tighten the regulating screw (2). Insert a cigarette paper between the contacts (3) and rotate slowly the crankshaft in the opposite direction of the engine rotation till the paper passes through the gap. This will occur when the gap between the points is sufficient for the paper to be removed (approx. 0.05 mm — 2 THOU).

At this moment the piston should be 2,3 to 2,6 mm (7/64") before TDC. Measure the distance

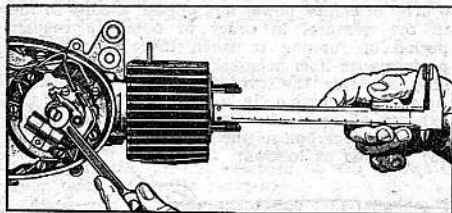

24. Setting the ignition advance

with a gauge (Fig. 24). If the ignition advance is still not correct, slacken the magneto clips (4) and rotate the whole magneto. Then repeat the setting till all the values are correct. Do not forget to retighten the clips after the setting. Then check the ignition advance and the contact breaker point gap.

9. DECARBONISATION

After every 3,000 miles (5,000 km) it is advisable to decarbonise (for the necessary dismantling see Part III). Burnt fuel residues (carbon) reduce the engine power and cause overheating. The carbon deposited on the top part of the piston, in the cylinder head and exhaust ports is best removed by careful scraping. At the same time remove the carbon from the piston ring grooves (using an old broken piston ring).

When assembling be careful to fit the ring into their original grooves. Having removed the carbon, wash the parts in petrol or paraffin.

Carbon deposits in the exhaust silencer cause

a drop in engine power and appear usually in the in the mixture. In order to obtain a regular period of running in when there is more oil performance it is necessary to clean the exhaust silencer after the first 900 miles (1,500 km). After the running in period decarbonise the exhaust silencer after every 1,500 miles (2,500 km). To decarbonise the exhaust silencer (Fig. 25) proceed as follows:

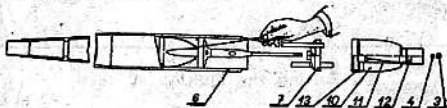

25. Decoking the exhaust silencer

a) With box spanner 10 remove the nut M 6 (3) and remove from the welded rod the end piece (1) together with the four-hole-plug (12).

b) Remove the end cone (10) and baffle (7). If the baffle is very clogged with carbon and cannot be pulled off the rod and the silencer body (6) easily, use a bent steel wire approx. 12 in. (300 mm) long and insert the bent end into one of the two openings in the baffle. Grip the other end of the wire with pliers and pull off the baffle.

c) Clean the dismantled parts with a wire brush and scrape off the carbon from the holes in the tail cone with a sharp steel tool. If the chromium plated parts are very clogged, it is possible to „burn them out“ (take care, as there is risk of fire, to carry out this operation in the open).

d) Scrape out with a sharp steel tool the holes in the baffle which is welded in the silencer body as well as the annular diffuser and

the oblong openings in the rod (see the illustration). Clean also the other parts of the exhaust silencer after dismantling.

10. SCOOTER MAINTENANCE TABLE

If regular maintenance is carried out the scooter will give you full satisfaction. Rely on the summary table of all the maintenance jobs up to the general overhaul; it will facilitate your task of regular servicing.

After a general overhaul the maintenance is the same as that of a new machine after the indicated mileage covered.

Note: The numerals in brackets refer to the lubrication points.

Scooter maintenance table

	Operation
1.	Thorough cleaning of the scooter
2.	Check tyre pressure — inflation
3.	Check the lights and buzzer
4.	Check and adjust the brakes
5.	Check the sparking plug, clean it and set the point gap
6.	Decarbonise the exhaust silencer
7.	Decarbonise cylinder head, piston, exhaust port and exhaust pipe
8.	Clean the induction silencer (9)
9.	Check and tighten all leads in their terminals.
	Check lead insulation
10.	Check and tighten spoke nipples
11.	Check and tighten all surface screws, bolts, nuts and pins, incl. engine fastening studs
12.	Check and clean the carburettor and the fuel tap
13.	Check and adjust the clutch
14.	Clean the contact breaker points and check the ignition advance
15.	Lubricate the contact breaker arm pin and felt (7)
16.	Clean and lubricate the rear chain on the machine (10)
17.	Check the rear chain tension
18.	Remove the rear chain, wash and lubricate it with graphited grease. Fit and adjust (10)
19.	Lubricate the hand lever pins (2) and foot brake pedal pin (3)
20.	Lubricate the telescopic front fork (4)
21.	Lubricate the wheel ball bearings (6)
22.	Lubricate the twist grip (8)
23.	Check and top up oil in the gearbox (5)
24.	Change the oil in the gearbox (5)
25.	Lubricate the throttle, clutch and brake control cables (14)
26.	Lubricate the kickstarter pedal pin (12), centre stand pin (13), speedometer drive (17), brake cams (11), and speedometer flexible shaft (16).
27.	Lubricate the steering head ball bearing (15)
28.	Check the operation of the pivoted rear fork dampers, if necessary, top up the damper liquid (18)

	Mileage covered:							Note
	0	600	1800	3000 9000	4500 10500	6000 12000	7500 15000	
	X	X	X	X	X	X	X	If necessary Before every ride
	X	X	X	X	X	X	X	
	X	X	X	X	X	X	X	
		X	X	X	X	X	X	If necessary First time after 900 miles
				X	X	X	X	Every 600 miles
		X	X	X	X	X	X	
		X	X	X	X	X	X	
		X	X	X	X	X	X	Every 500—600 miles
	X	X	X	X	X	X	X	
	X	X	X	X	X	X	X	
		X	X	X	X	X	X	Every 500—600 miles
		X	X	X	X	X	X	
		X	X	X	X	X	X	
	X	X	X	X	X	X	X	Every 500—600 miles
		X	X	X	X	X	X	
		X	X	X	X	X	X	
			X	X	X	X	X	Every 500—600 miles First time after 300 miles
			X	X	X	X	X	
			X	X	X	X	X	
				X	X	X	X	Every 500—600 miles
				X	X	X	X	
				X	X	X	X	
						X	X	Every 500—600 miles
						X	X	
						X	X	
								If necessary

III. DISMANTLING AND ASSEMBLING WITHOUT SPECIAL TOOLS

1. REMOVING THE FRONT WHEEL

To remove:

a) Unscrew the bowden cable nut and take the bowden cable off the brake cams lever.

b) Unscrew the wheel spindle nut remove the spring washer and wheel spindle.

c) Turn the R. H. front fork leg slider and remove the brake torque reaction anchor on the back plate from the opening in the fork leg and take the wheel off.

To replace:

A. Check the position of the brake cable rest on the handlebars.

B. Replace the wheel and turning the R. H. fork leg slider push the brake torque reaction anchor home on the back plate into the opening in the slider.

C. Replace the front wheel spindle from the left.

D. Replace the spring washer and screw the nut on from the right.

E. After replacing the cowl and the wheel on the machine push the bowden cable of the rear brake and the cowl rest. Push the bowden cable screw on the brake lever and adjust the brakes.

2. REMOVING THE REAR WHEEL

To remove:

a) Unscrew the rear wheel spindle nut and remove the spring washer.

b) Loosen the rear brake bowden cable from the clip (from the inside of the pivoted fork).

Unscrew the bowden cable nut and take the bowden cable off the brake cams lever.

c) Pull out the rear wheel spindle from the right (using the steel bar pushed through the hole in the spindle head).

d) Take of the brake torque reaction anchor.

f) Remove the wheel from the gear pins of the chain wheel, place it to the upper rear part of the rear cowl, take off the brake back plate from the wheel and put it freely over the left arm of the pivoted rear fork.

g) Catch the motorcycle at the grip on the rear cowl and lift it in so that the wheel could freely fall out.

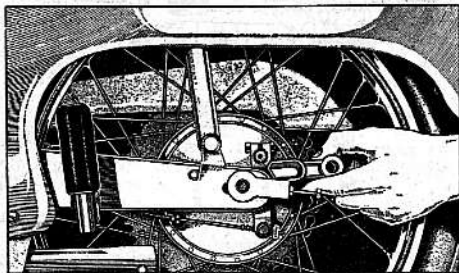

26. Rear wheel brake torque reaction anchor

To replace:

A. Check the position of the brake cable rest in the brake lever.

B. Place the wheel into the upper rear part of the rear cowl, push the brake back plate and push the wheel with the cowl on the pins at

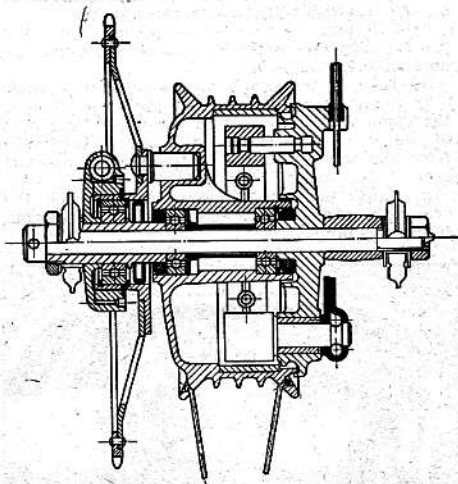

27. Rear wheel — sectional view

the chainwheel into the holes in the rubber inserts.

C. Place between the wheel and the fork arm the brake torque reaction anchor (Fig. 27) and push the spindle home. After replacing the cowl and the wheel on the machine push the bowden cable of the rear brake and the cowl rest. Push the bowden cable screw on the brake lever and adjust the brakes.

3. REPLACING THE WHEEL BALL BEARINGS

To remove:

- a) Remove the wheel.
- b) Remove the dust rings from both wheels and the circlip on the R. H. side.
- c) Push a thin rod through the L. H. bearing hole and the spacer tube bearing against the inner edge of the R. H. bearing. Tapping lightly on the rod knock the bearing out and remove the spacer tube.
- d) Using a suitable piece of tube knock out the L. H. bearing.

To replace:

- A. Insert from the left a steel sheet ring and pressing on the bearing outer race push the bearing until the circlip can be placed in position.
- B. Replace the spacer tube from the right and press the second bearing in.
- C. Check whether the L. H. bearing rests on the circlip and then push the dust rings home and replace the wheel.

4. REPLACING THE REAR CHAINWHEEL BALL BEARING

To remove:

- a) Disconnect the chain and remove the wheel.
- b) Unscrew the nut on the R. H. side of the rear chainwheel hub and remove the chainwheel.
- c) Take the speedometer drive out.
- d) Remove the rear chainwheel hub together with the dust ring.
- e) Remove the circlips and knock out the bearing across the circlip groove.

To replace:

- A. Refit the L. H. circlip.
- B. Fit the bearing and replace the R. H. circlip.
- C. Replace the chainwheel hub and dust ring from the left.
- D. Refit the speedometer drive from the right.
- E. Place the hub end with thread into the opening in the fork and tighten the nut slightly.
- F. Having replaced the wheel, tighten the chainwheel hub nut before tightening the wheel spindle nut.
- G. Check the wheel for free rotation.

5. TIPPING UP THE SEAT

To tilt the dual seat jerk its rear portion upwards and tilt it forwards. In its open position, the dual seat is secured with a trip. When closing the dual seat it is necessary to lift the trip and to tilt the seat easily down (see Fig. 33). The fuel tank filler and the tyre inflator are located under the dual seat.

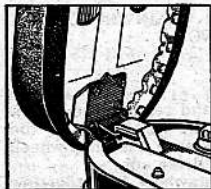

28. Tipping up the seat

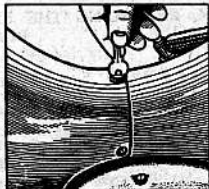

29. Securing the front cowl

6. DISMANTLING AND ASSEMBLING THE COWLS.

1. **The front cowl.** The front cowl where it joins the rear cowl is fastened with a screw with eccentric head. Turn the screw using a small coin or a key through 180 degrees:

Take hold of the bottom portion of the cowl, pull it lightly and lift. Now pull the whole cowl backwards until the hook in its upper portion slides out of the hole in the frame.

2. **The rear cowl** can be removed after taking off the seat. Tip up the seat and unscrew three M 6 x 10 screws fastening the seat to the frame. Disconnect the yellow lead leading to the tail lamp from the bakelite terminal.

After unscrewing two M 6 nuts in the top portion of the rear cowl, one M 6 x 10 screw fastening the cowl to the frame and four M 5 x 10 bolts with nuts holding the cowl to the footboard, pull lightly and lifting remove the cowl.

3. When removing the **front shield** remove first the front cowl, the air cleaner and the headlamp. Disconnect the flexible shaft from the speedometer head and unscrew the lead terminal from the ignition coil lead. Pull the flexible shaft and the lead together with the rubber grommets towards the engine. Unscrew three M 5 x 10 screws fastening the front shield to the top portion of the frame and 5 M x 10 screws holding the shield to the footboards.

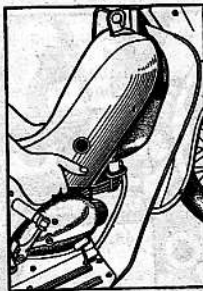

30. Removing the front cowl

To replace the cowls and the shield proceed in the reverse manner.

7. REMOVING AND REPLACING THE CYLINDER BARREL

To remove:

- Remove the front cowl, air cleaner, front shield, tunnel above the cylinder and loose the front shield.
- Remove the carburetter.
- Using spanner # 10 unscrew two nuts and remove the exhausts pipe from the studs.
- Using box spanner 10 unscrew the 4 cylinder head nuts.
- Kick down the kickstarter pedal. The cylin-

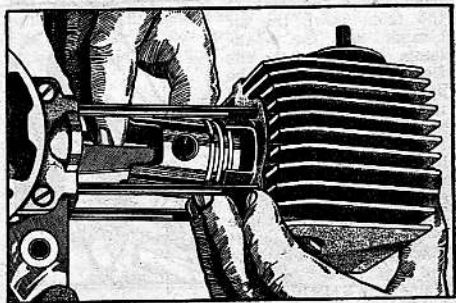

31. Fitting the cylinder barrel

der head sticking with carbon deposits will work itself free and can be easily removed.

- Take the cylinder barrel of the 4 studs.
- Cover the crankcase opening with a clean cloth to prevent dirt entering the crankshaft space.

To replace:

- Replace the gasket under barrel having oiled it from both sides.
- Push the cylinder barrel home on to the studs and piston taking care that the piston rings are correctly seated in the same position and in the same piston groove as before the removing. When replacing the cylinder barrel compress one piston ring after the other and turning it slip the barrel on to the piston to the crankcase.
- Provide the cylinder head seating face with a slight coat of sealing compound, fit it onto the cylinder and tighten with the four nuts.
- Screw on the exhaust pipe and the carburetter.
- Replace the tunnel, the front shield, the air cleaner, the lead with terminal and the front cowl.
- Having ridden the machine for some distance to warm up the engine, tighten the cylinder head nuts.

8. REPLACING THE PISTON RINGS

- Remove the cylinder head and the cylinder barrel (see Part III, Para 7).
- It is preferable to remove the piston rings with three thin steel sheet strips. Slip one strip under the ring in the middle and the two at its ends and pull the ring off (Fig. 32).

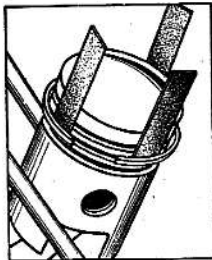

32. Replacing the piston rings

To replace:

- A. Fit the piston rings one after the other according to Fig. 32.
- B. Check the piston ring play in the grooves by rotating the rings.
- C. Set the piston ring gaps against the pegs in the piston grooves.
- D. Replace the cylinder barrel and head.

9. DISMANTLING THE HEADLAMP

The headlamp consists of two main parts: rim with reflector and nacelle.

To remove the rim with reflector:

- a) Unscrew the fastening screw on the bottom side of the rim.
- b) Tip the rim with reflector upwards and remove.
- c) If necessary, disconnect the leads from the terminals.

It is possible to remove the piston rings by merely stretching them with the fingers. But this has to be done with great care to avoid breaking the ring.

The piston rings have to be replaced as soon as the gap exceeds 0,8 mm (32 THOU) (the correct gap of the new ring is 0,2 mm — 8 THOU). To check the gap place the removed ring into the top portion the cylinder barrel.

If access to the bulb is necessary, the leads need not to be disconnected, it will be enough to compress the socket and rotate.

When reassembling before tightening the fastening screw make sure that the rim is correctly fitted on to the top portion of the headlamp nacelle.

If the front fork or steering head have to be removed it is also necessary to remove the headlamp nacelle.

- a) Remove the rim with reflector and disconnect the leads from the socket.
- b) Remove the front cowl and the R. H. engine side cowl.
- c) Disconnect the throttle cable from the carburetter (see Part III, Para 14).
- d) Disengage the control cables from both handlebar levers (Para 14 and 16).
- e) Disconnect the speedometer flexible shaft (Para 13).
- f) Unscrewing two M 3 nuts disconnect both leads from the buzzer.
- g) Using spanner # 10 slacken the handlebar spindle and tapping with a wooden hammer free the handlebar ring from the stem.
- h) Pull out the handlebars with throttle cable and leads by slight rotation.
- i) Unscrew with spanner # 10 two screws from the headlamp nacelle and remove the brake and clutch cables after tipping the nacelle slightly.

To replace:

- A. Pull the leads and the three cables through the 2 rubber grommets in the headlamp nacelle and at the same time fit the stem with handlebars through the third grommet to the steering head and tighten the handlebar spindle.

See that the spindle taper is with several threads on the spindle.

B. Fasten the headlamp nacelle to the telescopic front fork with two bolts and nuts.

C. Connect the speedometer flexible shaft.

D. Connect the brake and clutch cables to the handlebar lever (see Para 15 and 16).

E. Screw on the R. H. engine side cover with three screws and connect the throttle cable to the carburetter (see Para 14).

F. Screw on two green leads to the buzzer and two blue ones to the headlamp socket.

G. Replace the rim with reflector and the front cowl.

10. DISMANTLING THE FRONT FORK

a) Remove the headlamp nacelle (see Part III, Para 9) and dismantle the choke coil from the covering sheet.

b) Disconnect the top straps on the rubber sleeves.

c) Using box spanner # 10 unscrew the nuts in the top cups of the fork legs and to make reassembly easier unscrew also the plugs.

d) Push the slider with spring downwards.

To replace:

A. Lubricate the sliders with grease and push the sliders with springs home.

B. Screw in the plugs and the # 10 nuts. Do not forget the spring washers.

C. Replace the rubber sleeve straps and fix the choke coil on the covering sheet.

D. Make the front fork play.

E. According to Part III, Para 9 replace the headlamp nacelle and headlamp.

11. PIVOTED REAR FORK

Before dismantling the pivoted rear fork carry out the following operations:

1. Remove the rear wheel (Part III, Para 2).
2. Remove the rear chainwheel (Part III, Para 4).

To dismantle:

a) Slacken the bolts holding the suspension units on both sides of the pivoted rear fork.

b) Using a press drive out the pivoted fork pivot from the rubber blocks which completes the dismantling.

To reassemble proceed in a reverse manner. It is recommended to replace the pivoted rear fork only in a repair shop.

12. REPLACING THE SPEEDOMETER FLEXIBLE SHAFT

To dismantle:

a) Remove the front and rear cowl.

b) Remove the headlamp, unscrew from the speedometer head the flexible shaft knurled nut and remove the shaft through the opening in the front shield together with the rubber grommet towards the engine.

c) Remove the chainguard unscrewing two screws with spanner # 9.

d) On the pivoted fork R. H. arm, unscrew the nut with spanner # 14 and remove the clip.

e) Unscrew the knurled nut on the speedo-

meter drive housing on the rear wheel and remove the shaft.

To reassemble proceed in reverse manner.

Note: If the flexible shaft cable breaks but the casing is not damaged it is enough to replace the cable. When replacing the cable it will be necessary only to remove the headlamp, to unscrew the knurled nuts on both ends of the casing and pull out the broken cable. The oiled new cable can be fitted from either end of the casing.

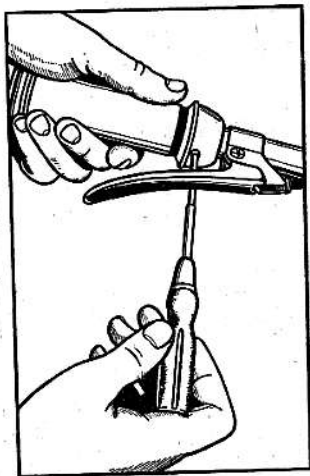

33. Adjusting the throttle twist grip

13. REPLACING THE THROTTLE CABLE

To remove:

- a) Remove the headlamp and the front cowl.
- b) Unscrew the carburetter mixing chamber top and pull it out together with the throttle valve. Having slackened the nut, screw the throttle cable adjusting screw right into the chamber top.
- c) Compress the spring disconnect the throttle cable and remove the throttle valve together with the top.
- d) Slacken the two studs in the twist grip retention cap.
- e) Turn the twist grip so as to enable unscrewing of the screw securing the plug in the handlebar through the side opening. Pull off the grip together with the plug.
- f) Lift the catch link and remove the throttle cable end. Pull out the retention cap together with the throttle cable and casing.

To replace:

- A. Pull the cable with casing through the R. H. handlebar and headlamp nacelle.
- B. Connect the cable end in the retention cap groove and fit the retention cap on the handlebar.
- C. Slip the cable end into the catch link which should be inserted into the handlebar groove.
- D. Connect the other end of the cable to the carburetter top.
- E. Pull the cable end until the catch link comes to a stop at the retention cap. Fit the spring and throttle valve to the cable.
- F. Fit the throttle valve into the carburetter body and screw on the top.

G. Slip the twist grip and plug onto the handlebar and screw the plug to the handlebar through the twist grip hole.

H. Push the retention cap towards the twist grip so as to take up the axial play and secure by tightening the rear stud.

I. With the front stud, set the required ease of rotation of the twist grip and check its operation (Fig. 34).

14. REPLACING THE CLUTCH CABLE

To remove:

- a) Remove the front cowl and headlamp.
- b) After unscrewing 3 screws (5, Fig. 20) on the R. H. side of the engine and depressing the brake pedal, remove the R. H. engine side cover.
- c) Slackening the screw, pull out the cable from the end piece on the R. H. side cover.
- d) Pull out the thrust washer from the clutch lever bracket and twisting the cable, push the trunnion sleeve out of the clutch lever.
- e) Having completed this work it is possible to replace as required either the cable complete with casing or only the wire.

To replace:

When replacing only the cable it is necessary to lubricate the wire with oil. To replace proceed in the reverse manner and after refitting the control cable adjust the clutch as described in Part II, Para 6.

15. REPLACING THE BRAKE CABLE

To replace:

a) When replacing the control cable complete unscrew the bowden cable nut and take the bowden cable off the brake cams lever.

b) Remove the headlamp. Free the front brake cable from the handlebar lever in the same manner as the clutch cable.

c) Free the rear wheel brake cable with the screwdriver slackening the screw through the hole in the L. H. floorboard.

To replace proceed in reverse manne.

16. REMOVING THE ENGINE FROM THE FRAME

a) Remove the cowl (Part III, Para 6) and the air cleaner.

b) Disconnect the fuel line, the throttle and clutch cable and the gear change pedal rod.

c) Disconnect the chain.

d) Unscrew the 4 M 8 fastening bolts.

e) Take out the engine.

To replace:

A. Place the engine in the frame and tighten the 4 M 8 bolts.

B. Replace the chain, the fuel line, the throttle and clutch cable and the gear change pedal rod.

C. Fit the cowls (Part III, Para 6).

D. Check the running of the engine and having ridden a short distance tighten all screws, bolts and nuts.

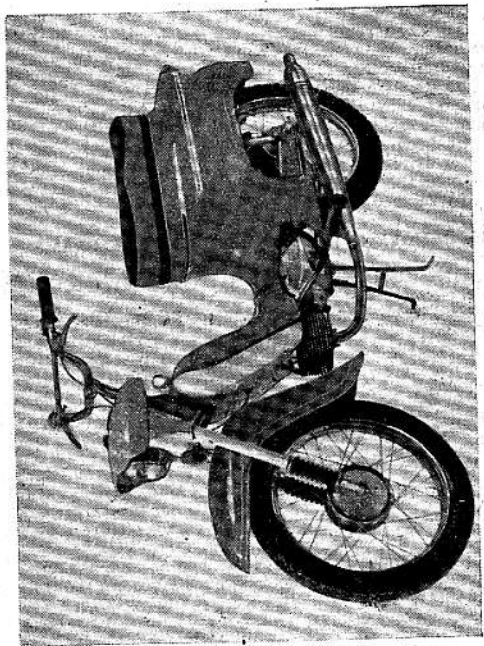

34. Jawa 50 Model 05 Sports

JAWA 50 MODEL 05 SPORTS

The JAWA 50 Ultra-Lightweight, model 05 Sports, is derived from the JAWA 05 standard model.

A typical feature are the wide handlebars with crossbar and quick-action throttle twist grip. It possesses no enclosure or footboards. Motor cycle type footrests are employed instead.

The JAWA 05 Sports is available with standard tyres size 2.75 x 16 in. For trials purposes, the owner can replace the rear tyre with the S 9 trials rear tyre size 2.75 x 16 in., available as a spare part.

This sports model is intended above all for young riders and for competing in sporting events.

Technical data, servicing, maintenance and lubrication are identical with the description in the Owner's Handbook for the JAWA 05 standard model.

Spare parts are identical with those for the JAWA 05 standard model. Minor differences are shown in the Spare Parts List.

IV. DEFECTS, CAUSES AND REMEDIES

Fault	Location	Remedy
Lumpy running	Engine is pinking	<p>Let engine cool off, do not run at high revolutions</p> <p>Replace sparking plug</p>
	Engine is pinking	<p>Remove head and decarbonise</p> <p>Set ignition</p> <p>Dismantle and clean exhaust silencer, if necessary, straighten pipe</p>
Engine misfires	Engine overheated	<p>Clean carburettor</p> <p>Open tap completely (reserve), top up, check fuel feed and filler cap breathing hole</p> <p>Tape crack in insulation, or, preferably replace lead</p>
	Regular spark	<p>Clean jet, adjust carburettor</p> <p>Stir mixture properly before re-fuelling</p>
Engine misfires	Water or oil in carburettor	
	Insufficient fuel supply	
Engine misfires	Temporary short circuit of lead against cylinder or frame	
	Lean mixture	
Engine misfires	Incorrectly mixed petrol	
	Regular spark	

Lumpy running	Engine misfires	Irregular spark	<p>Replace sparking plug</p> <p>Remove and clean sparking plug</p> <p>Set gap to 0.5 mm by bending outer plug point</p> <p>Clean points with cloth dipped petrol</p> <p>File with a fine file</p> <p>Set gap to 0.4 mm</p> <p>Replace condenser</p>
	Engine misfires	Irregular spark	<p>Replace sparking plug</p> <p>Oiled sparking plug</p> <p>Excessive sparking plug point gap</p> <p>Solled contact breaker points</p> <p>Burnt contact breaker points</p> <p>Incorrect contact breaker point gap</p> <p>Faulty condenser, the ignition is out of function</p>
Engine will not fire - engine has stopped	Engine misfires	Temporary short circuit of lead against cylinder or frame	<p>Tape crack in insulation, or preferably, replace lead</p>
	Carburettor can be flooded	Empty fuel tank	<p>Turn fuel tap to open reserve (approx. 18 miles) and refuel as soon as possible</p> <p>Open fuel tap</p>
Engine will not fire - engine has stopped	Carburettor can be flooded	Fuel tap closed or insufficiently open	
	Carburettor can be flooded	Fuel tap closed or insufficiently open	

Engine will not fire — engine has stopped			Carburettor can be flooded			Carburettor can be flooded			Carburettor can not be flooded			Spark at lead end			No spark at lead end								
Engine will not fire — engine has stopped						Carburettor can be flooded						No spark at lead end											
Clogged screen above fuel tap						Choked fuel feed or carburettor screen						Choked breathing hole in fuel tank filler cap						Remove fuel tap and clean screen Remove feed and blow through, remove carburettor and clean jet Clean breathing hole					
Oiled sparking plug						Burnt contact breaker points						Switch box lever in incorrect position						Replace ignition coil					
Damaged plug insulation						Faulty ignition coil						Soiled contact breaker points						Wipe points with cloth dipped in petrol					
Plug point gap either excessive or insufficient						Burnt contact breaker points						Faulty contact breaker						File with fine file					
Switch box lever in incorrect position						Faulty contact breaker points						Soiled contact breaker points						Have contact breaker points repaired or replace					
Burnt contact breaker points						Faulty contact breaker						Switch box lead broken or loose						Replace lead, if impossible connect and insulate with tape, but replace soon					
Switch box lead broken or loose						Burnt lead insulation												Tape lead, but replace lead as soon as possible					

Engine will not fire — engine has stopped			Carburettor can be flooded			Spark regular			Poor compression			Sparking irregular			No spark at sparking plug points			No spark at lead end											
Engine will not fire — engine has stopped						Carburettor can be flooded						Sparking regular						No spark at lead end											
Faulty condenser						Broken piston ring						Replace condenser						Have magneto repaired											
Damaged stator winding						Seized piston ring						Water in contact breaker						Blow water out, dry carefully or let dry						Replace terminal					
Insulation						Leaking sparking plug washer						Damaged bakelite lead terminal						Remove ring and replace						Remove, clean and fit (or replace)					
Water in contact breaker						Seized piston												Replace sparking plug washer						Seal with sealing compound					
Damaged bakelite lead terminal						Damaged cylinder head gasket																		Dismantle and have repaired in specialised workshop					

Engine will not start or has stopped. Carburettor can be flooded.	Compression normal	Engine overheated Insufficient lubrication Throttle cable broken Faulty seal between carburettor and cylinder	Let engine cool off, keep it running at low revolutions Take care to mix fuel mixture properly and at correct ratio Replace throttle cable Replace seal or tighten carburettor stub
	Faulty Carburettor	Choked jet Faulty float Float stuck Faulty float needle	Remove and clean jet Have float repaired or replace Free float Repair or replace
Engine lacks power	Permanently	Cylinder head and barrel, exhaust port and exhaust silencer clogged with carbon Fuel feed partly choked Incorrect ignition advance setting	Remove cylinder head and barrel, if necessary exhaust silencer and decarbonise Remove and clean fuel feed Set correct contact breaker point gap and ignition advance

Engine lacks power	Permanently	Carburettor incorrectly set (bad mixture) Throttle valve stuck Clogged exhaust silencer Cylinder inside and piston worn Engine draws false air (Damaged crankcase halves or carburettor stub seal) Brake shoes rub against drums	Set idling jet, needle position and clean air cleaner Free and adjust throttle valve to work properly Dismantle and decarbonise Have cylinder rebored, replace piston and rings, check piston bearing for wear (workshop) Separate crankcase halves, clean seating faces, insert new paper gasket compound and tighten fast. Replace carburettor stub seal Adjust brakes
	Temporarily	Partly clogged fuel feed or screen in tap or carburettor Throttle cable sticks Engine overheated Faulty sparking plug	Clean fuel feed or screens Lubricate cable, if necessary, replace Let engine cool off and keep at low revolutions Replace plug

Published by After-Sale Service Department, Považské strojárne, Nat. Corp., Považská Bystrica.
Printed by Tlačiarne SNP, Nat. Corp., Ružomberok.
Czechoslovakia

**MOTOKOV, PRAHA
CZECHOSLOVAKIA**